



A matter of brightness

Light for educational institutions





Vienna University of Economics and Business Campus
Vienna, AT – by Zaha Hadid Architects,
NOMAD Arquitectos, Estudio Carme Pinos

Learning more effectively with the right light

Light greatly influences well-being and concentration. It makes a significant contribution to how well students, pupils, and kindergarten children can find their way around and focus at educational institutions.

Lighting needs to remain flexible to cater to a wide range of new teaching formats. In lecture halls and classrooms, excellent, reflection-free vision is a top priority, while reduced-glare and balanced brightness protect the eyes from fatigue. Luminaires should create a pleasant ambience in libraries and cafeterias. Additionally, they play a representative role in the assembly hall or outdoors.

Light also influences mood. Cool daylight white promotes attention while warm white light has an inspirational and relaxing effect. Biodynamic lighting supports learning and regeneration by adapting to the human rhythm throughout the day. In addition to lighting, room acoustics have a significant impact on successful learning. Acoustic elements optimise speech intelligibility and reduce noise, thus improving presentations and cutting distractions during conversations.

By using smart luminaires, the lighting system can be more sustainable and efficient with the help of state-of-the-art technologies. Intelligent sensor technology coordinates natural lighting conditions with artificial light, and presence-controlled lighting systems save energy. Above all, the lighting of an educational institution creates security and identity – and crafts an environment in which students and pupils find their way around, feel a sense of belonging and enjoy learning.

Light for all areas

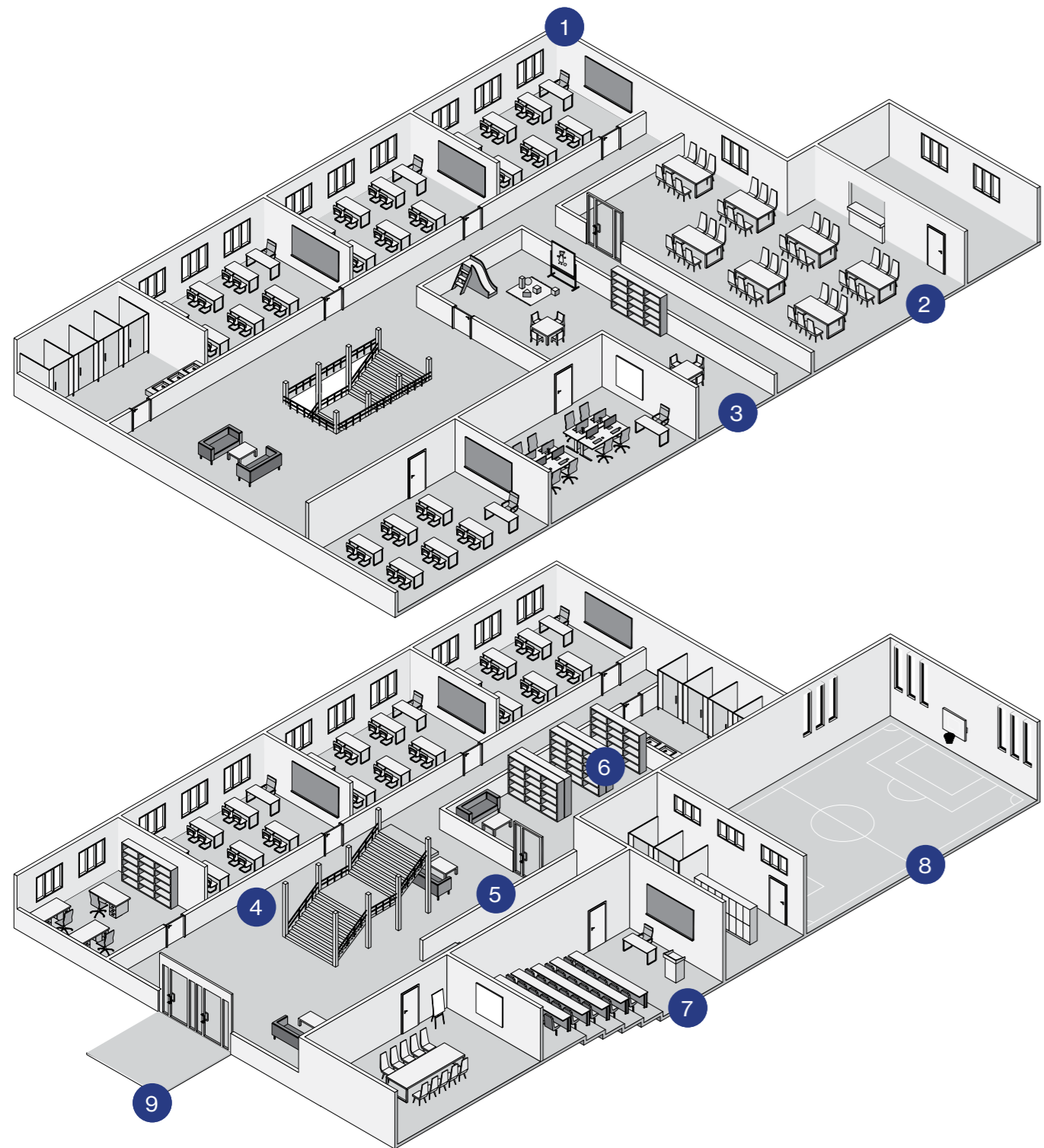

- ① Classrooms 12
- ② Cafeteria 24
- ③ Kindergarten 28
- ④ Assembly hall 36
- ⑤ Corridors and staircases 40
- ⑥ Library 44
- ⑦ Lecture hall 48
- ⑧ Sports hall 52
- ⑨ Outdoor 56

Appropriate lighting for schools 60

Harmonious light thanks to modern sensor technology 62

Acoustics for educational institutions 64

Design variety

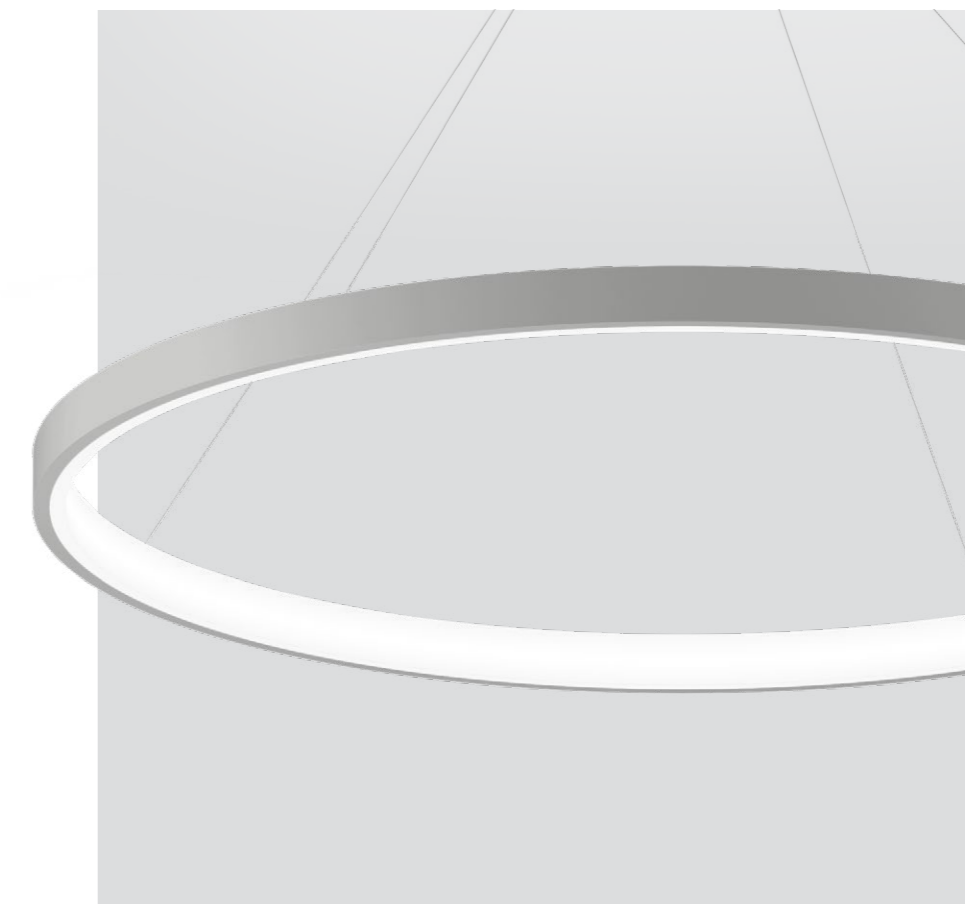

Luminaires provide a pleasant ambience and a good learning atmosphere in educational institutions while underlining each building's individual character. XAL has a large selection of different recessed, surface-mounted, and suspended luminaires in various shapes and colours to adapt to your preferences.

INO circle / square
surface/suspended

Plasterboard ceiling / concrete ceiling
2700K, 3000K, 4000K,
TW (Tunable White)

Ideal application
Kindergartens, Cafeteria,
Assembly halls

Colours
white, grey, black, and special colours

XCS Customised Solutions

Some visions fill space, others create it. Even the most extensive product portfolio cannot always meet a design's specific requirements. That is why we work with you to develop bespoke lighting solutions that are precisely tailored to the architectural and aesthetic needs of your project. Depending on the size of the project, we implement both minor adaptations to existing XAL products and designs of completely new innovations.



Special colours

Colours have a decisive influence on the effect of rooms and buildings. Their task is to complement and round off an architectural vision. That is why we offer a vibrant colour selection to deliver the highest possible creative freedom to adapt to your design. XAL's most popular product families come in discreet classic colours, intense trend colours, and the special gold and bronze jewellery tones.

VELA
suspended

Plasterboard ceiling / concrete ceiling
3000K, 4000K

Ideal application
Kindergartens

Colours
white, grey, black, and special colours



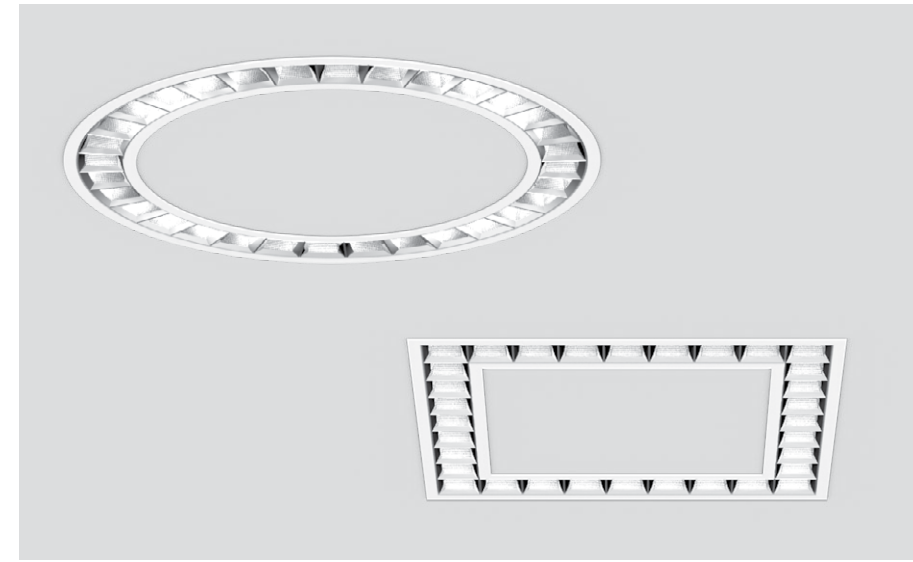

Descreet perfection

MITA circle/ square
recessed

Plasterboard ceiling/ grid ceiling
3000K, 4000K, TW (Tunable White)
UGR ≤ 19

Ideal application
Classrooms, cafeteria, assembly halls,
libraries

Colours
white, black

The square difference

FLOW
surface

Plasterboard ceiling/ concrete ceiling
3000K, 4000K
IP 40

Ideal application
Cafeteria, corridors

Colours
white, grey, black,
and special colours

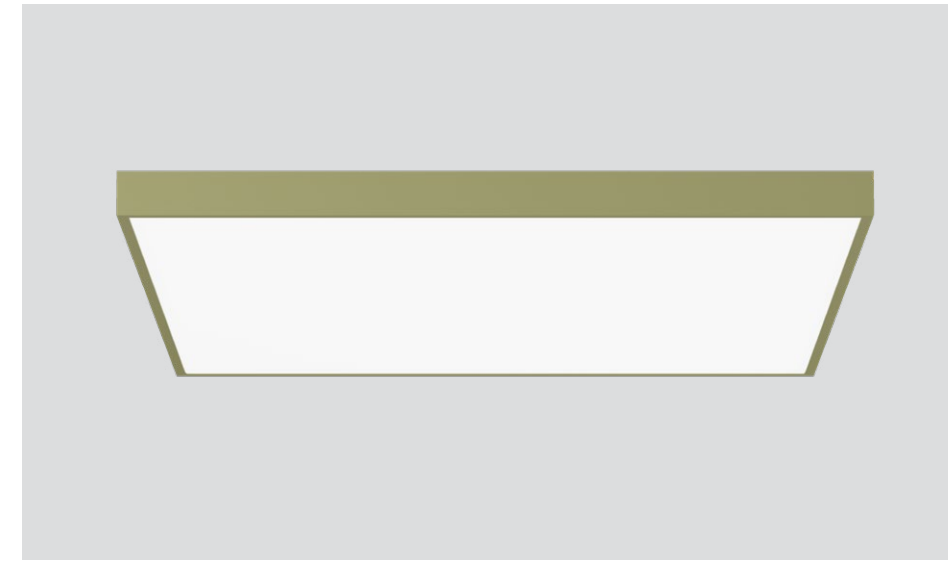

Slim and smart

BETO circle
suspended

Plasterboard ceiling/ concrete ceiling
3000K, 4000K, UGR ≤ 16

Ideal application
Assembly halls, corridors

Colours
white and black

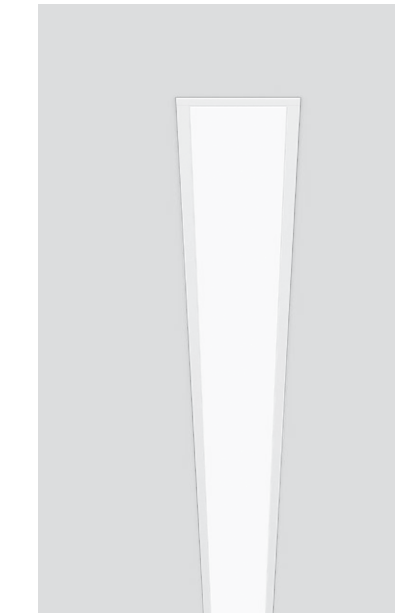
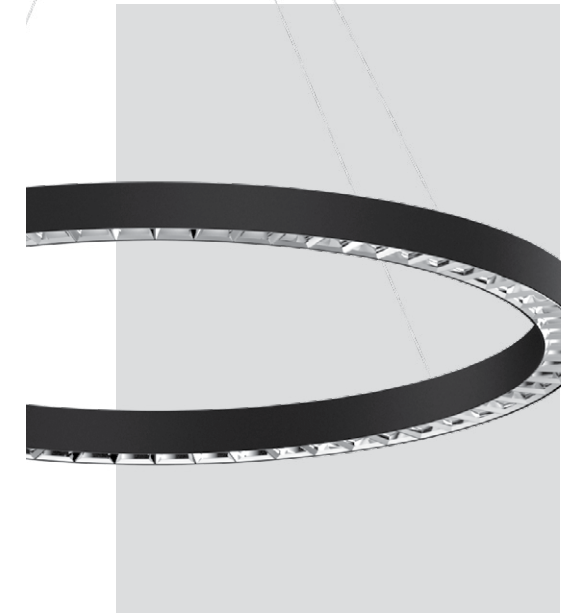

Shaping the environment

HEX-O
surface/ suspended

Plasterboard ceiling/ concrete ceiling
3000K, 4000K, TW (Tunable White)
UGR ≤ 19

Ideal application
Libraries

Colours
Luminaire: white, black, and
special colours
Acoustic elements: white, black

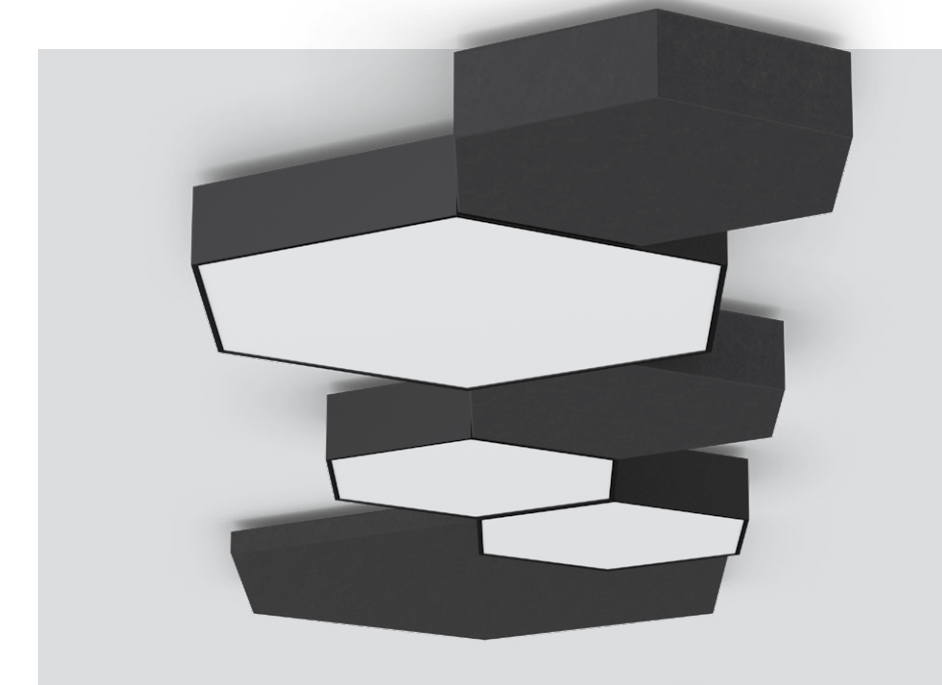

Shape the light

UNICO square/ linear
recessed

Plasterboard ceiling/ grid ceiling
2700K, 3000K, 4000K,
TW (Tunable White), UGR ≤ 19

Ideal application
Classrooms, corridors, lecture halls

Colours
white, black

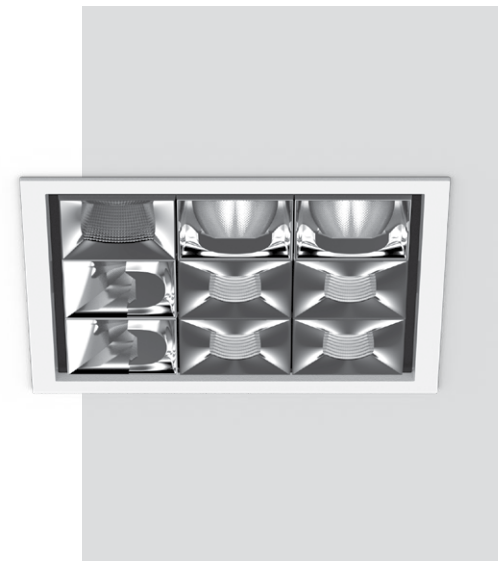

Ultra slim series

TASK round/ square
surface/ suspended

Plasterboard ceiling/ concrete ceiling
3000K, 4000K, TW (Tunable White)
UGR ≤ 19

Ideal application
Classrooms, cafeteria, assembly halls,
libraries

Colours
Luminaire: white, black,
and special colours
Acoustic elements: white, felt grey,
marble grey, and black

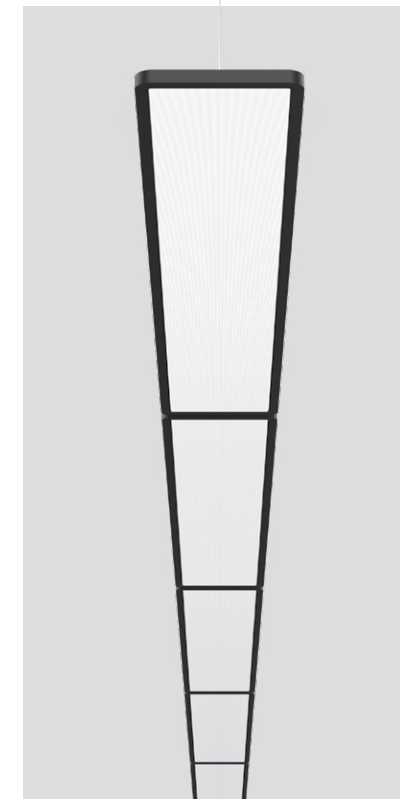

Light in perfect circles

MINO circle
surface/ suspended

Plasterboard ceiling/ concrete ceiling
3000K, 4000K, TW (Tunable White)
UGR ≤ 19

Ideal application
Kindergartens, cafeteria, assembly halls,
corridors

Colours
white, grey, black,
and special colours

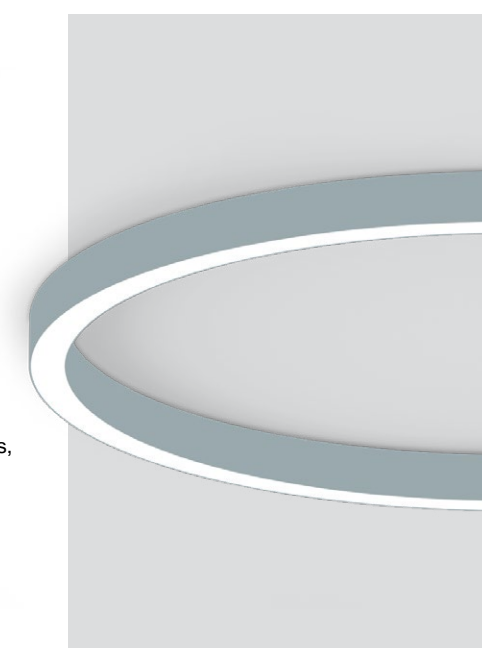

Be free to sharpen your profile

FRAME 40/ 60/ 100 system
MINIMAL 60/ 100 system
recessed

Plasterboard ceiling/ concrete ceiling
3000K, 4000K, TW (Tunable White)
UGR ≤ 19

Ideal application
Classrooms, kindergartens,
cafeteria, assembly halls, corridors,
libraries, lecture halls

Colours
FRAME: white, grey
MINIMAL: white



Enlightened by acoustics

SONIC
suspended

Plasterboard ceiling/ concrete ceiling
3000K, 4000K, UGR ≤ 19

Ideal application
Assembly halls

Colours
Luminaire: white, dark grey, and
special colours
Acoustic elements: white, marble grey,
and black



High-precision wallwashing

SQUADRO wallwasher
recessed

Plasterboard ceiling/ grid ceiling
3000K, 4000K

Ideal application
Classrooms

Colours
white and black



Combine with your design

SASSO 40/ 60/ 100
recessed/ semi-recessed/ surface

Plasterboard ceiling/ grid ceiling
2700K, 3000K, 4000K, CWD (Colour
Warm Dimming), UGR ≤ 16

Ideal application
Kindergartens, cafeteria, corridors

Colours
Mounting frame: white, silver, and black
Housing: white, black
Reflector: white, silver-matt, black,
gold, and chrome

For heavy-duty use

SONO
surface

Plasterboard ceiling/ concrete ceiling
3000K, 4000K, TW (Tunable White)

Ideal application
Kindergartens, assembly halls,
corridors, outdoor (SONO IP)

Colour
white



TASK S system
suspended

Plasterboard ceiling/ concrete ceiling
3000K, 4000K, TW (Tunable White)
UGR ≤ 19

Ideal application
Classrooms, cafeteria, libraries

Colours
Luminaire: white, black
Acoustic elements: white, felt grey,
marble grey, and black



MINO 40/ 60/ 100
system/ customised
surface/ suspended/ ceiling offset

Plasterboard ceiling/ concrete ceiling
3000K, 4000K, TW (Tunable White)
UGR ≤ 19

Ideal application
Classrooms, kindergartens, cafeteria,
assembly halls, corridors, libraries,
lecture halls, sports halls

Colours
white, grey, black
and special colours

Perfect allrounder

TUBO
surface/ suspended

Plasterboard ceiling/ concrete ceiling
3000K, 4000K

Ideal application
Cafeteria, assembly halls, corridors

Colours
white

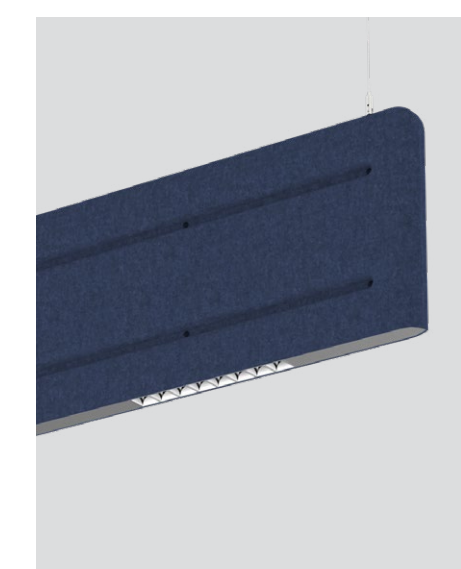

The sound of stress-free work

MUSE
suspended

Plasterboard ceiling/ concrete ceiling
3000K, 4000K, UGR ≤ 19

Ideal application
Classrooms, Assembly halls

Colours
anthracite, grey, light blue, indigo blue

Light quality

Light quality has a major impact on successful learning. XAL develops luminaires of the highest quality to meet the requirements of modern educational institutions. Our products are fitted with high-end LEDs. Excellent glare reduction is critical for teaching and learning, which is why we use micro-faceted reflector technology to complement our proven micro-prismatic cover. The UGR values thus guarantee excellent, glare-free learning conditions everywhere.

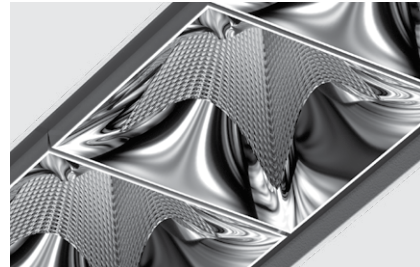

BETO system / wallwasher surface / suspended

Plasterboard ceiling / Concrete ceiling
3000K, 4000K, TW (Tunable White)
UGR ≤ 16

Ideal application
Classrooms, Lecture halls

Colours
white and black



TW – Tunable White

Changes in the colour of light have a substantial effect on our mood. Tunable White allows the colour temperature to be continuously adjusted from 2700K

(warm light) to 6500K (cool light) to dynamically adapt the lighting to the time of day or ambient brightness.

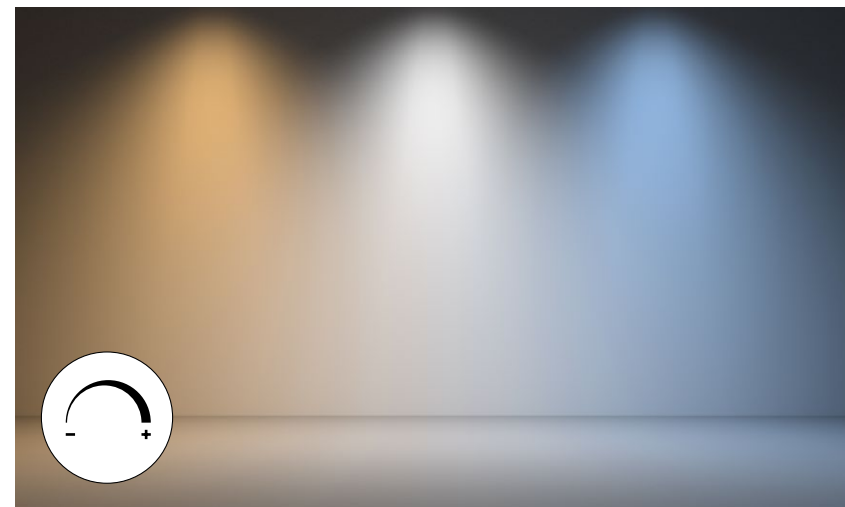

Advanced sensor technology



Presence sensors regulate workplace light according to whether someone is present, while brightness sensors adapt the light intensity to the ambient brightness. This means that if desks, rooms, or corridors are unoccupied, the light switches off automatically after a set delay. Furthermore, the luminaire increases or decreases its brightness depending on the ambient brightness. This saves energy and extends the service life.

Classrooms



Light influences learning success

Learning is a dynamic process. In schools and universities, teacher-centred instruction is increasingly giving way to modern teaching and learning methods. For these to work, the right lighting in the classroom is crucial, because our ability to concentrate correlates with the lighting conditions.

Carefully planned classroom lighting increases the students' attention and well-being. Lighting needs to be uniformly bright and flexible to ensure excellent visibility from any location despite varying space utilisation. Modern lighting systems are capable of adjusting the brightness level to the needs of the user. In the morning, for example, regular lessons are held. Children need a light intensity of 300 lux to follow lessons without tiring.

The focus of good classroom lighting is still on blackboard illumination. Whether a classic blackboard or a modern whiteboard, this area should receive 500 lux, with a high degree of uniformity (0.7), to guarantee optimum perception and legibility even from the back of the room. For presentations, however, it makes sense to dim the lighting system or only illuminate parts of the room. Pre-programmed scenes can, for example, be called up via a lighting management system and thus support changing teaching formats.

The best light source in classrooms is daylight. Sensor-controlled lighting uses incidental natural light and harmoniously adjusts the artificial light to it for a pleasant atmosphere that facilitates communication and promotes successful learning.

Lighting requirements (EN 12464-1)

- light intensity of at least 500 – 1000 lx for room lighting for day classes
- controllable lighting with for different activities and light scenes
- For classrooms used by small children (primary school), a required illuminance of 300 lx may be used by dimming
- light intensity of at least 500 lx on blackboard/whiteboard
- good glare control in all directions (UGR ≤ 16/19)
- ideally separately switchable lighting (blackboard & room light)
- ideally use of daylight and presence sensors

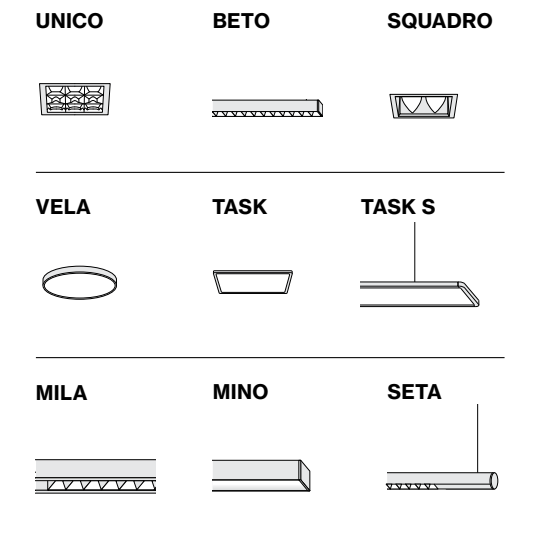

Sekundarschule Wasgenring
Basel, CH –
by Stähelin Partner Architekten AG



Maria-Ward-Schule
Nürnberg, DE – with lighting design
by Konzeptlicht, Gregor Sgonina



Elementary School Puntigam
Graz, AT –
by Franz und Sue ZT GmbH



International School
Copenhagen, DK –
by C.F. Møller Architects with
lighting design by Anders Smith

A high degree of flexibility

Copenhagen International School

Together with Anders Smith and lighting designer Michael Anker, Jørgen Juul from the architectural firm C.F. Møller Architects developed the lighting solution for Copenhagen International School. They are responsible for all didactic, architectural, and design decisions.

The new building, boasting an impressive 25,000 square metres, is located at Copenhagen's northern harbour and is unique in many ways. From the start, the focus was on using light to create the best possible learning, teaching, and working environment. This requires flexibility and adjustability to adapt the right light to the right situation. Since the school accommodates children from 3 to 18 and adults of all ages, adjusting the colour temperature and intensity had to be quick and intuitive. Various activities can thus be supported. The installation itself must also offer flexibility, both for current and future applications. The suspended luminaires are connected to tracks and are height-adjustable, enabling significant changes. Small adaptations can be made directly via the app or the wall switches, allowing the end-user to adjust the light quality and intensity. Each luminaire must be independently and intuitively controllable via the same interface in a small, simple, and attractive housing.

The aim was to create an environment where general lighting differs from workplace lighting; a warm space, but with cool, intense light for precise work. This required a much higher lux level (1000 lux) on the table surface than the standard 500 lux. Studies show this improves learning and increases student performance.



Anders Smith
Lighting designer, anders smith design



Jørgen Juul
Architect, C.F. Møller Architects

“XAL was the right partner for us because of the reduced, aesthetic luminaires, the understanding of design, the high quality, and the willingness to implement our vision with a bespoke solution.”

Anders Smith, lighting designer



International School
Copenhagen, DK –
by C.F. Møller Architects with
lighting design by Anders Smith



School Campus Neustift
Stubaital, AT
by fäsch&fuchs.architekten



The school of tomorrow

School campus Neustift

The school campus in Neustift in the Stubaital by fäsch&fuchs.architekten is one of the showcase projects for the "school of tomorrow". The fascinating architecture does complete justice to the idea of open learning. The buildings for the primary and junior high school, the polytechnic and the skiing-focussed junior high school were harmoniously set into the slope in three stages and covered with cascades. VELA and MINO ensure creative continuity within the rooms with their simple, clear design and universal applicability. The luminaires were integrated into the acoustic ceilings or suspended freely, depending on requirements and the room. This created a consistently homely atmosphere for living and learning on campus.

School campus Neustift
Stubaital, AT –
by fasch&fuchs.architekten



Cafeteria



Encounter and regeneration: A matter of light

Cafeterias are communication hubs. They bring people in educational institutions together and offer a spatial and mental time-out. Pupils, students, and teachers often only have short breaks between lessons. An atmospheric lighting concept is thus all the more critical.

Increased natural light in a canteen boosts the quality of stay. Dynamic lighting management systems balance available daylight with artificial light to create a bright, friendly atmosphere with optimised energy consumption. The most pleasant lighting is a combination of indirect lighting and accent lighting.

Table lighting is particularly important in cafeterias and canteens. To ensure good visual conditions, tables should be illuminated with 200 lux (according to EN 12464-1) without glaring or concealing those sitting at the table. Lighting with balanced direct and indirect light shows faces, facial expressions, and gestures clearly and distinctly and makes people stand out from the background without casting shadows.

The canteen is often a multi-purpose room that is also used for events or celebrations – in such cases, changeable lighting scenes for different lighting moods are ideal. Luminaires with high colour rendering properties ($CRI \geq 90$) stimulate the appetite by presenting food and the ambience in a particularly appealing way while allowing those at a shared table to appear in natural light.

The cafeteria has an important role to play as a place where learners can stay. With a well-thought-out lighting design, your premises will be conducive to long-term relaxation and good communication.

Lighting requirements (EN 12464-1)

- A light intensity of at least 200 lx, uniformity of 0.4 / glare reduction of $UGR \leq 22$
- Higher colour rendering of $CRI \geq 90$ for a good visual ambience
- Warm light colours (2700K/3000K) for a pleasant lighting mood
- Mixture of accentuated and indirect light
- Different lighting moods delivered by lighting scenes for varying uses of the space
- Use of daylight for improved well-being and to save energy

SASSO



SASSO



TULA



VELA



TASK



MINO



INO



MINO



FRAME

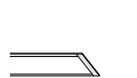

XUND education centre
Lucerne CH –
by Metron AG with lighting design
by Bühlmann Engineering AG



UA92
Manchester, UK –
by BDP Architecture



Maria-Ward-Schule
Nürnberg, DE –
by Konzeptlicht, Gregor Sgonina

Kindergarten



Light that creates trust

The kindergarten is one of the first places young children explore and learn new things. It is, therefore, particularly important that the environment conveys an atmosphere of trust. Balanced lighting makes a significant contribution to this.

Indirect light and the use of incidental daylight create a pleasant atmosphere. With the aid of brightness sensors, the light intensity and colour temperature of the artificial light can be dynamically adjusted to suit daylight. This saves energy, and the natural lighting conditions make it easier for children to feel comfortable in unfamiliar surroundings.

Kindergarten lighting should also meet various requirements. The EN 12464-1 standard stipulates light intensity of at least 300 lux where people play, sing, do handicrafts, or draw. The luminaires should be glare-free, with $UGR \leq 19$ or $UGR \leq 22$ depending on the visual task requirements. The aim is to create visual comfort and to respond flexibly to the needs of children. With the right lighting management system, different lighting scenes can be programmed and changed according to the occasion. In this way, lighting can be used to create differentiated zones even in a large, multifunctional room. This grants the children an intuitive sense of orientation.

A friendly, warm white light colour increases the sense of well-being and gives children a feeling of security and comfort. The design of the luminaires can contribute to this. A lighting concept for kindergartens and nurseries dispenses with technical appeal and instead focuses on soft, open forms.

Lighting requirements (EN 12464-1)

- playrooms: light intensity of at least 300 lx, high uniformity (at least 0.4), good glare control ($UGR \leq 22$)
- craft rooms: light intensity of at least 300 lx, high uniformity (at least 0.6), good glare control ($UGR \leq 19$)
- balanced light distribution and use of daylight for improved well-being
- lighting scenes for multifunctional rooms
- direct-indirect lighting for pleasant conditions
- friendly and warm white light colours (2700K/3000K) for improved well-being

SPADO



COMBO



SONO



HEX-O



MINO circle

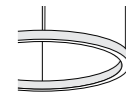

MUSE

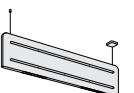

MILA



FRAME

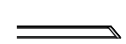

MINO



Kindergarten & Day care center
Looren, CH –
by L3P Architekten ETH
FH SIA, AG



Kindergarten Hauderweg
Linz, AT –
by Mia2 Architektur ZT KG



Kindergarten
Schlierbach, AT –
by Wolf Architektur,
Marco Kienesberger



A second home

Kindergarten Schluderns

The idea behind the design of the kindergarten was to give the architecture the iconographic form of a house, thus creating a friendly and familiar environment for children. The prominent windows of various sizes on the façade, with their staggered arrangement and dimensions, were intended to evoke an oversized child's drawing.

The main demand of the architects was not to build an educational institution, but a second home for the children. For example, floors and furniture were made of oiled solid wood and fabric covers of cotton. The materiality and feel of the products were to be more reminiscent of a residential building than a public building. This concept was also to be reflected in the lighting. The aim was to provide optimum lighting for the play and learning areas while creating a homely, comfortable lighting atmosphere, familiar to the children from home. The entire lighting was designed to be dimmable to adapt the lighting situation to the different didactic needs.

Planning suitable for children requires a scale suitable for children. The furniture and individual components were adapted to the size of a child. For example, the stairs in the kindergarten have a step height of 12 cm, rather than the standard 17 cm. Although this is somewhat odd for adults, it is far more comfortable for children.

Thanks to the timber construction method, all solid timber walls and ceiling elements with millings and drillings for the lines to be installed later for ventilation, heating, power distribution, light points, etc. were already defined in detail during the planning stage. This required very precise planning, making this stage more time-consuming, but reducing the construction time significantly.

“In all our projects, we take care to create 'healthy' spaces in sustainable buildings in which the users feel comfortable. For example, the kindergarten in Schluderns was deliberately constructed as a wooden building and attention was paid to the use of materials that are not harmful to health and are as ecologically sound as possible.”

Roland Baldi, architect



Roland Baldi
Architect, Roland Baldi Architects



Kindergarten
Schluderns, IT –
by Roland Baldi Architects

Assembly hall



The representative room

The assembly hall is not merely a multifunctional space. As a centrepiece for educational institutions, it also plays a representative role. The lighting should create an atmospheric ambience and provide a stage for a wide range of events – from theatrical performances to graduation ceremonies.

A professional lighting concept is required because assembly halls, foyers, and entrance areas are used in so many different ways. Optimum ambient lighting is achieved with relatively wide-area light at 200 lux and light intensity uniformity of 0.4. Safety and straightforward orientation are key. Separately controllable light zones are ideal for visually structuring a spacious room. This enables, for example, the stage area to be well illuminated while the assembly hall is darkened. Smart sensor technology saves energy in the long term, particularly in large room structures. Brightness sensors detect natural daylight and switch on artificial light only when necessary.

A flexibly designed lighting management system also offers the option of zoning and accentuating individual areas of the room, for example, by using targeted highlights with wall spots. Variable light colours and scenes deliver various lighting scenarios and exciting lighting moods to suit the occasion.

Last but not least, emergency and safety lighting is an essential part of lighting design for auditoriums and entrance halls. Where necessary, independently powered emergency lighting systems or luminaires with emergency lighting functionality provide immediate orientation, and guidance systems show the way outdoors.

Lighting requirements (EN 12464-1)

- light intensity of at least 200 lx (uniformity of 0,4 / glare reduction of $UGR \leq 22$)
- vertical lighting (walls) allow for better orientation and illumination of the room volume
- use of daylight to save energy (brightness and motion sensors)
- emergency and safety lighting when needed

SASSO



VELA



SONO



TASK



MITA



SONIC



INO



MINO



TUBO

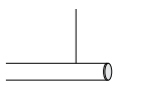

Grammar school
 Buchloe, DE – by
 LRO Architekten with
 lighting design by ratec licht



Maria-Ward-Schule
 Nürnberg, DE –
 by Konzeptlicht, Gregor Sgonina

Corridors and staircases



Orientation, ambience, and safety

Lighting creates a pleasant atmosphere while ensuring good orientation and safety. Well-thought-out lighting design of the building circulation supports students and pupils by intuitively helping them to find their way around their educational institution and feel comfortable.

As a visual guidance system, lighting guides people through the building, which is particularly important in large and initially confusing schools or universities. Sufficient lighting (at least 100 lux) is essential to feel safe and comfortable and to be able to evacuate the building quickly in an emergency. As well as providing general lighting, indirect ceiling lighting or illuminated walls in corridors can make the room appear larger and improve orientation and the quality of stay. In stairwells, however, sufficiently bright (at least 150 lux) and glare-free light ($UGR \leq 25$) must be ensured. Contrasts help to make steps easily perceptible.

Light also emphasises important information. Separately switchable accent lights help visually accentuate elements such as building plans or noticeboards. Pure functionality is not always the focus. The lighting should also create a pleasant atmosphere where zones are used as recreation areas during breaks in class.

A building's circulation infrastructure has an important place within the lighting design and in the evaluation of the energy balance. Presence and daylight sensors help to reduce energy costs. For example, they ensure that corridor lighting is only switched on when there is movement, or by using natural daylight and supplementing it with artificial light only when necessary.

Lighting requirements (EN 12464-1)

- stairs: light intensity of at least 150 lx (uniformity of 0.4 / glare reduction of $UGR \leq 25$)
- corridors: light intensity of at least 100 lx, uniformity of 0.4 / glare reduction of $UGR \leq 28$
- presence and daylight sensors to save energy
- separately switchable accent lighting for building plans or noticeboards
- Plan vertical lighting - illuminated walls in corridors make the space appear larger

UNICO



SASSO



SPADO



SONO



VELA



MINO



TUBO



LINEA



MINO



Maria-Ward-Schule
Nürnberg, DE –
by Konzeptlicht, Gregor Sgonina



Business School
Manchester, UK –
by BDP Architecture



Maria-Ward-Schule
Nürnberg, DE –
by Konzeptlicht, Gregor Sgonina

Library



The long-term place of learning

Students often spend many hours of concentrated reading and working in libraries. A friendly environment is thus just as important as lighting conditions that maintain focus over an extended period. An appropriate lighting concept noticeably increases the quality of stay and learning.

The harmonious light distribution between direct and indirect light creates the best conditions for reading, researching, or working at a computer for extended periods. To ensure that library visitors are not disturbed by other light sources, all luminaires should have exceptional glare control ($UGR \leq 16/19$). Microprismatic luminaire enclosures counteract direct and reflected glare and are ideal for computer workstations or tables with glossy surfaces.

Above all, the eyes must not tire during long reading sessions. Using suitable suspended luminaires and mobile floor luminaires or switchable table luminaires delivers an adequate lighting level in reading areas of 500 lux at $UGR \leq 16/19$. For extended, focused work, the standard requires a modified illuminance of 750 lux for the reading area.

Accent lighting helps students orient themselves and find media more quickly. The emphasis on rows of shelves and signage guides the eye and creates a spatial structure. Libraries in the right light thus offer space for extensive research and individual in-depth study.

Lighting requirements (EN 12464-1)

- bookshelves: light intensity of at least 200 lx, uniformity of 0.6
- reading area: light intensity of at least 500 lx - 750 lx, uniformity of 0.6
- good glare control at computer workstations ($UGR \leq 19$)
- good ambient lighting for building circulation orientation and a luminance $< 3000 \text{ cd/m}^2$
- accent lighting for shelves/doors for targeted perception
- balanced direct-indirect lighting for concentrated work and reading

TASK



TASK S



TASK table



VELA



HEX-O



BETO



FRAME

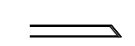

MINO



MOVE IT 45 system



University Währingerstraße
Vienna, AT –
by NMPB Architekten ZT GmbH



Triplex university library and lending desk
Heidelberg, DE –
by ap88 Architekten Partnerschaft mbB
with lighting design by LDE BELZNER HOLMES

Lecture hall



Flexible light for mental agility

Lecture halls are central to education and discourse. Successful lighting creates optimal conditions for teaching and presentations by providing good visibility, focussing attention on the plenary and supporting various teaching formats.

New, teaching methods at universities and technical colleges that use technology place additional demands on lighting design. Architecturally, many lecture halls are designed so that they can be completely darkened for projector presentations. As a result, artificial lighting must perform all the more. Dynamic lighting control and pre-programmed light scenes are indispensable to create the best working lighting for variable teaching methods.

Sufficient light intensity (300–500 lux) is important around the lectern so that lecturers can be easily seen from any seat. If the blackboard is used, it should be illuminated with the lowest possible reflection. The lighting requirements in such cases is 500–750 lux with an increased uniformity of ≥ 0.7 . The right lighting solution creates conditions where students can take notes without glaring. This is achieved, for example, by profile luminaires arranged in parallel above the rows of chairs. In addition to homogeneous basic lighting and very good glare control, they ensure a structured and modern appearance.

Last but not least, safety in lecture halls plays a role. Entrances and exits, stairs and steps must be lit separately so that students can safely enter and leave even a darkened lecture hall. A forward-looking lighting concept takes into account the numerous scenarios and remains agile – like a curious mind.

Lighting requirements (EN 12464-1)

- lecture hall: light intensity of at least 500–750 lx, uniformity of 0.6 / glare reduction of $UGR \leq 19$
- light in the podium area: light intensity of at least 300–500 lx, uniformity of 0.7
- blackboard: light intensity of at least 500 lx, uniformity of 0.7
- ideally individually controllable lighting (room light/board light/lectern)
- orientation lighting during lectures (entrances and exits, stairs and steps)

UNICO



SASSO PRO



MENO



VELA



FRAME

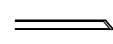

MINO

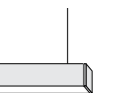

LINEA



STREAMCUT



UNICO



Instituto de Empresa
Madrid, ES –
by Serrano-suñer Arquitectura,
Dmo arquitectos



Business School
Manchester, UK –
by BDP Architecture

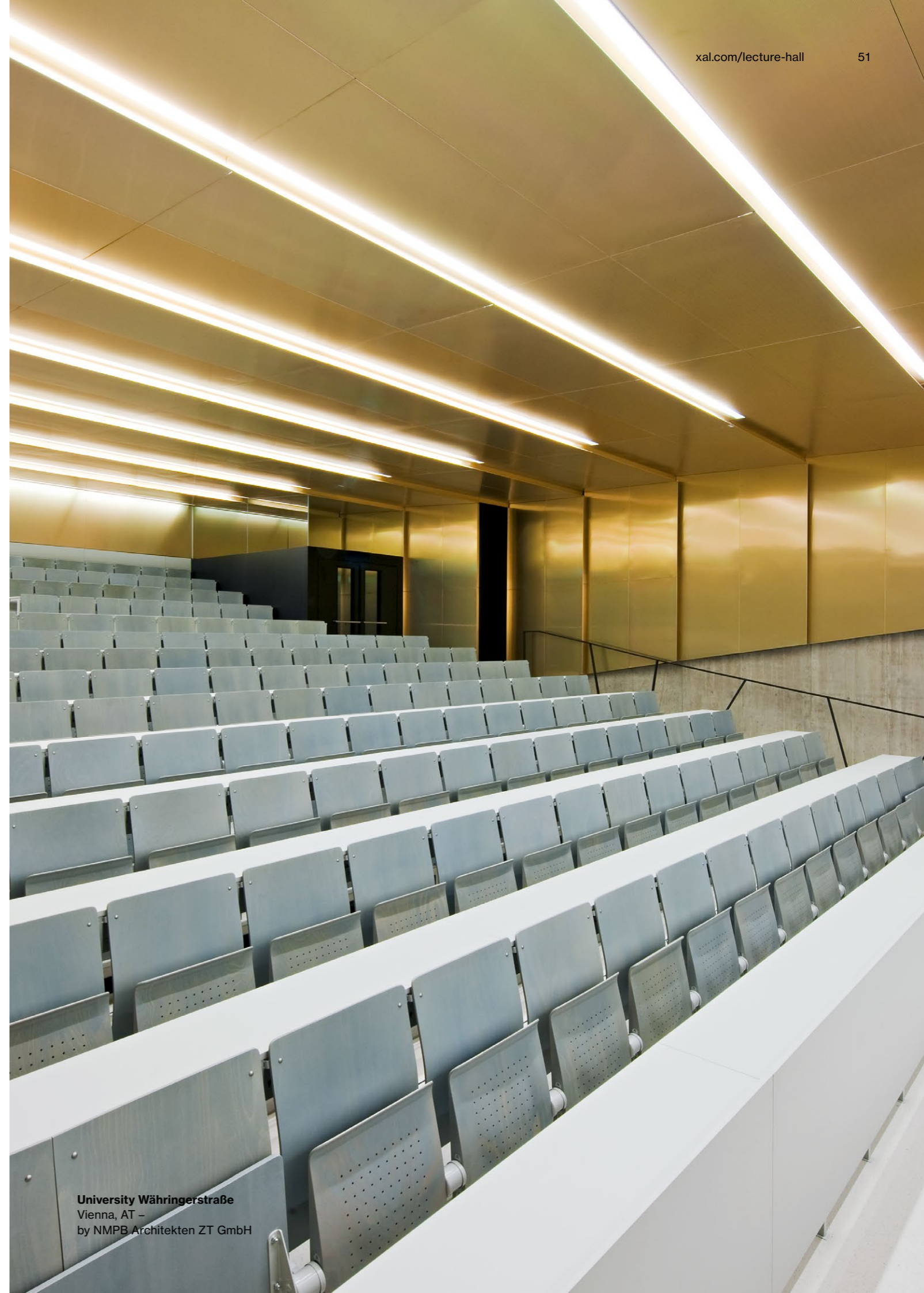

University Währingerstraße
Vienna, AT –
by NMPB Architekten ZT GmbH

Sports hall



What light must achieve in competitions

A wide range of activities takes place in sports halls from football tournaments to gymnastics lessons. The lighting should, therefore, be appropriate for most sports and games while meeting important safety standards.

Lighting design is based on the type of sport that has the most demanding visual task. Different regulations apply to sports hall lighting depending on whether the hall is used for school sports or for competitive club sports. EN 12464-1 stipulates a light intensity of at least 300 lux with a uniformity of 0.6 for normal use. The values are higher for competitions.

Wide-area luminaires or profile luminaires are powerful and well suited for homogeneous illumination. In either case, highly efficient luminaires with a neutral white light colour are advisable.

A key requirement for lighting in sports halls are shock and ball-impact resistant luminaires that do not break when struck by a ball. Because players look upwards in many sports, the luminaires must also be highly glare-free (min. UGR ≤ 22). Separate lighting control of individual areas is needed in very large halls. It makes it possible to create appropriate lighting scenes for different sports, events, or competitions or to switch off certain areas, e.g. where only parts of triple or multi-purpose halls are used.

Lighting requirements (EN 12464-1)

- for school and sports halls: light intensity of at least 300 lx - 500 lx, uniformity of 0.6 / glare reduction of UGR ≤ 22
- shock and ball-impact resistant luminaires
- good colour rendering (CRI ≥ 80) with neutral white light colour (4000 K)
- separately controllable lighting for multi-purpose hall use

MINO



ARENA

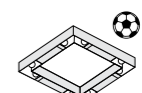

Sports Park Lissfeld

Linz, AT –
by sps architekten with lighting
design by Instaplan Technisches
Büro für Elektrotechnik

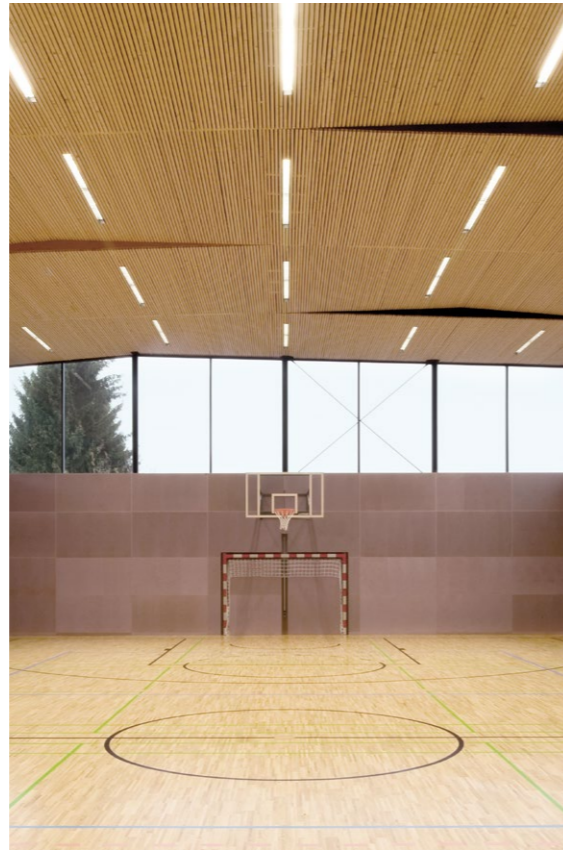
**Raiffeisen Sports Park Hüttenbrennergasse**

Graz, AT –
by projektCC zt gmbh and lighting design by
Hailight Lichtplanung, Andreas Haidegger

**Raiffeisen Sports Park Hüttenbrennergasse**

Graz, AT –
by projektCC zt gmbh and lighting design by
Hailight Lichtplanung, Andreas Haidegger

Outdoor



Outdoor safety and orientation

The outdoor area of educational institutions is often used as a sport, play, and leisure area. Pupils and students spend their breaks or free periods there, can let off steam, soak up the sun and regenerate their minds.

Lighting fulfils two main functions here: safety and orientation. The top priority in outdoor lighting design is the prevention of accidents. Lighting can be used to draw attention to potentially dangerous spots such as steps, obstacles, or garage exits, making them clearly visible even in poor lighting conditions.

Steps or depressions are best identified by a glare-free, sufficiently bright light. Contrasts help reveal the obstacle's true dimensions. Paths, entrances, or property boundaries can be clearly marked with bollard luminaires. Shock resistant and weatherproof surface-mounted wall luminaires are suitable for the building facade. These luminaires also function excellently as signposts on outside staircases. In general, steps and railings can be accentuated by light and thus made even safer.

Outdoors, lighting is subject to great stress – especially from the weather. Luminaires should be shock resistant, durable, and impervious to water, insects, and dust. As exterior lighting is also part of the initial visual impression, it should complement the architecture of the building positively. Lighting design is, therefore, about functionality and the overall aesthetic effect.

Lighting requirements

- luminaires with greater protection against water, insects, and dust (min. IP 44 / 54)
- good illumination of entrances, exits, and stairs for improved safety
- glare-free and uniform light for better orientation
- accentuated facade lighting completes the architecture's overall aesthetic effect

SONO



BASO

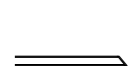

DOC



STREAMCUT



Wasgenring secondary school
Basel, CH –
by Stähelin Partner Architekten AG



Sports park Lissfeld
Linz, AT –
by sps architekten with lighting design by
Instaplan Technisches Büro für Elektrotechnik



University Research Institute
Ulm, DE –
by bizer architekten

Appropriate lighting for schools



It is well-known that light strengthens general well-being and positively influences concentration and performance. The lighting choice is therefore especially essential in schools for its biological benefit and thus successful learning.

Pale lighting scenes in classrooms should be consigned to the past. Natural daylight plays an important role as it changes continuously in intensity and colour temperature. Cold light has an activating effect, while warm light is calming for the pupils.

When artificial light adapts dynamically to this process and takes into account the different teaching units, it increases both well-being and successful learning. Whether mathematics lessons, homework, creative units, or breaks – biodynamic light gives young people a boost in their everyday school life.

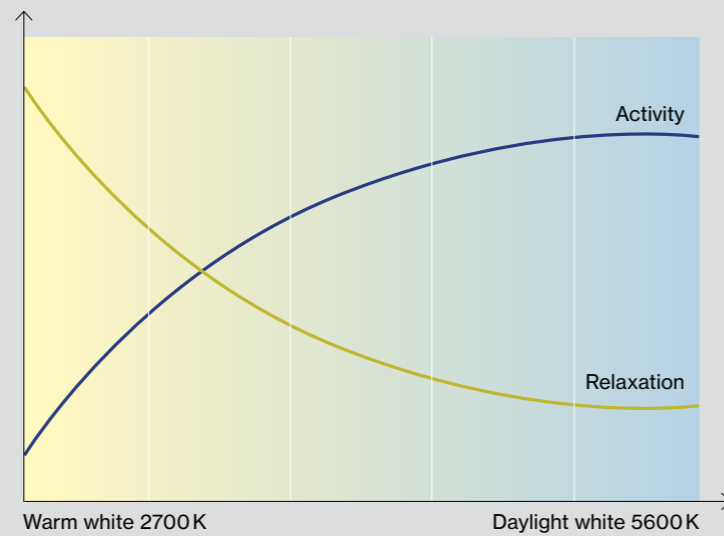

TASK S system
suspended

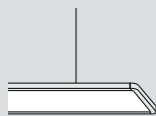

MINO
suspended

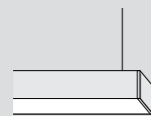

BETO system
suspended

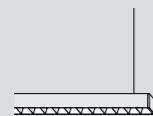

VELA
surface

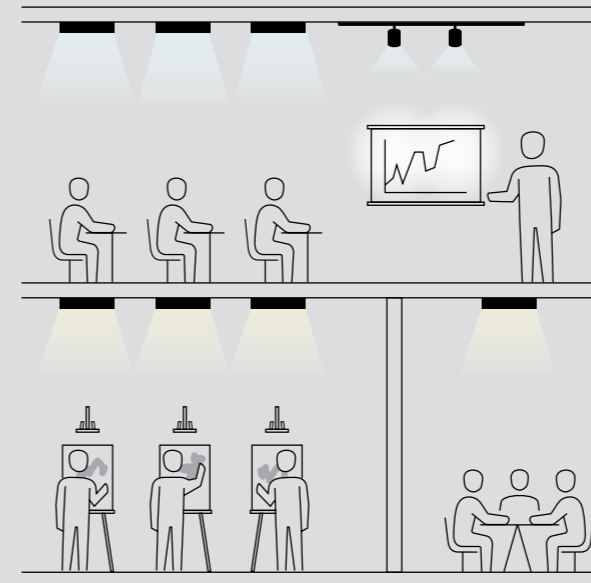

Promoting creativity and concentration with light colours

Lighting solutions for biodynamic light enable much more than just changing the light at the push of a button. The intensity and colour of the light can be adapted to suit the classroom situation.

Cold white, cool light colours have an activating effect and promote concentrated work (5000 K). They are particularly suitable for schoolwork or mathematics lessons, for example. Warm light colours (between 2700 K and 3000 K), however, have an inspiring, calming, and relaxing effect, thus supporting creative work such as art classes.

Pre-programmed lighting scenes can easily be selected at the touch of a button. Teachers can respond to the activities and needs of pupils and have a positive influence on their well-being and successful learning. All XAL's Tunable White luminaires already meet exactly these requirements.

A sky in the classroom

At XAL, we work intensively on the effect of light on the circadian rhythm (day-night rhythm). Together with WIEN ENERGIE and ASCR (Aspern Smart City Research), the positive effect on students has been proven.

An artificial sky is created in the classroom with a specially developed wall profile luminaire. A pre-programmed dynamic light (from cool white light in the morning to warm white light in the evening) imitates the natural course of the day. The light intensity is reduced during the breaks to achieve the most relaxing effect possible. The excellent colour rendering of the LEDs ($R_a \geq 95$) makes objects in the room look alive and encourages children's curiosity. In addition to the bright ceiling illumination, supplementary spotlights directed at the walls are essential. Only these direct spotlights create the impression of existing sunlight which has a stimulating effect.

A simple switch interface ensures that the lighting scene can be set according to requirements. Teachers choose from the 'concentrated work', 'creative work', 'break', and 'relaxation' programmes. Additional button symbols for switching the table light on and off and spotlights for when sitting in circles complete the touch interface. This delivers the greatest possible flexibility for the lessons.



- 1 concentrated work
- 2 creative work
- 3 break
- 4 relaxation

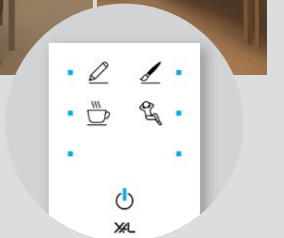

Harmonious light thanks to modern sensor technology

Clever lighting design offers many advantages for learners and teachers. This begins with the use of natural daylight, which is perceived as more pleasant and promotes concentration. It extends to significant energy savings through automatic switching off luminaires in empty rooms. Flexible lighting management allows the selection of different lighting programmes to suit the specific teaching methods and to best support pupils in their learning.

Lighting solutions that can be both automated – for example, in brightness management using smart sensor technology – and manually adjusted by speakers are ideal. A further advantage of modern sensors is the possibility of evaluating data. This allows information about room and energy use to be collated and educational institutions to be optimised accordingly. A smart classroom does one thing above all: It adapts to people.

The best light anywhere

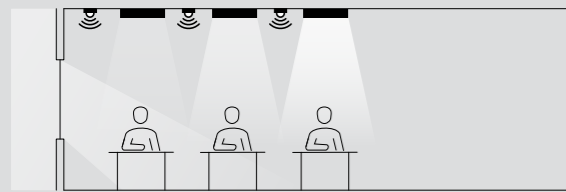

Uniform brightness is a room's most pleasant lighting atmosphere. Daylight is optimal for well-being and attention, which is supplemented by artificial light in places farther away from the window.

Brightness sensors in the luminaires measure the naturally incidental light and homogenise the lighting in the room. This creates a positive atmosphere while saving energy.

Luminaires often remain lit even when classrooms are unoccupied, for example during free periods or breaks. Presence sensors activate the light when people enter the room and switch the light off when they leave. The same principle can be used to reduce energy consumption for corridor and WC lighting. Instead of switching off the corridor lighting completely, it can be dimmed to a minimum level during lessons.

UNICO L6 pro
recessed



BETO system
suspended

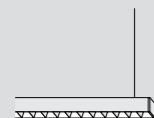

TASK S
suspended



TASK S system
suspended



Adaptive classroom lighting

Board light

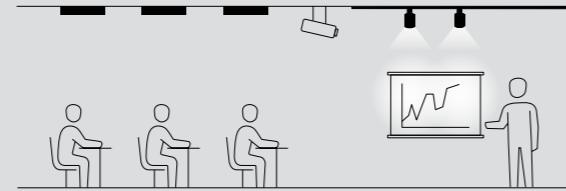

Ambient light

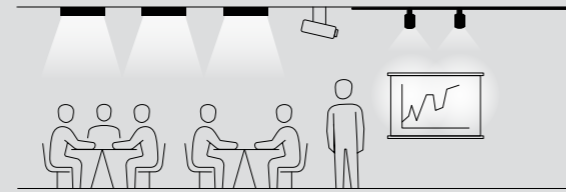

Multimedia

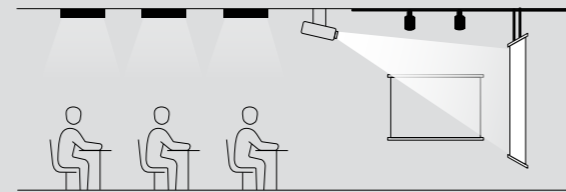

Modern teaching methods are diverse and varied, making flexible lighting all the more important. This is where a lighting management system is particularly useful. Lighting scenes can be stored as programmes and teachers can call up and change them simply by pressing a button or using a control display, whether for a teacher-centred lecture, evening class, or media presentation.

The board light should be manually controllable, independently of the room light, because an optimal, reflection-free view from any place is crucial. Illuminance can be raised from the minimum value of 500 lux to the modified value of 1000 lux by means of a control element depending on the requirements, for example during tests. If there is a need to take notes or work in groups during a lesson, the light can be dimmed for a 'Multimedia' scene in the board area and intensified on the table surface. This allows teachers to provide ideal learning and working conditions at the touch of a button to best meet the class's needs.

The right lighting solution for every room

A good lighting solution adapts to people and the environment. XAL luminaires integrate into the existing building control system as well as into the classroom's architecture. Sensor-controlled ZigBee luminaires thus avoid unsightly wiring in historic buildings and blend in visually. The luminaires have a further advantage. They can be integrated into any system – whether a stand-alone solution for individual classrooms or a comprehensive management system for all trades.

Please get in touch for tailored consultation for your project. Please contact us at controls@xal.com

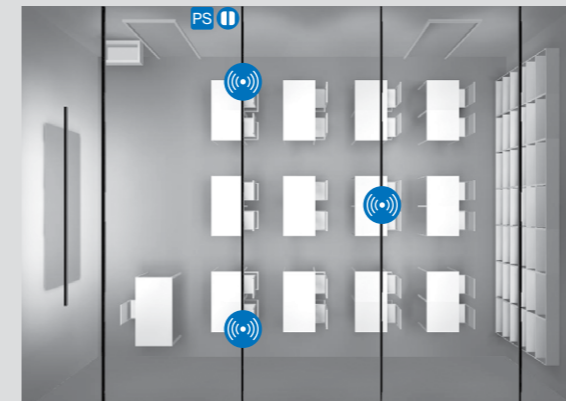

Stand-alone: customised and optimised

Flexible lighting management, ideal for individual classrooms, is delivered by our DALI-controlled luminaires with integrated multi-sensors for brightness or presence control. The light is divided into direct and indirect components to achieve uniform illumination. Different scenes can be set and activated for blackboard presentations, table, or room lighting. Launching these scenes is performed via a Bluetooth app or wall switch.

	Sensor	3
	DALI Power Supply	1
	DALI 2 Controller	1



Wireless stand-alone: easy retrofitting

Wireless multi-sensors work with Bluetooth. This means that they can be retrofitted without making structural changes to the luminaires. Presence sensors save energy by automatically switching on and off. The brightness is regulated by pre-programmed groups and scenes and adjusted to the incidence of daylight.

	Sensor	3
	Switchcoupler	1
	Wireless Module	13 (per luminaire and sensor)

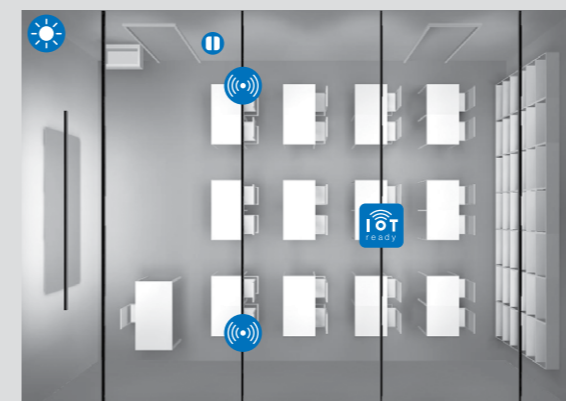

Total IoT centrally controlled solution

Controlling multiple rooms simplifies lighting management and can be linked to windows, blinds, and other equipment. Further functions include Human-Centric Lighting, air quality and noise measurement, and web visualisation.

	Sensor	2
	Switchcoupler	1
	Light Management Set	1
	IoT Sensor	1
	Commissioning	1

Acoustics for educational institutions

Concentrated, effective learning with good acoustics

Seeing and hearing are key to perception. Optimal room acoustics are as essential as lighting for teaching and successful learning. Learning in educational institutions is still based on communication, even in the multimedia age of indispensable mobile devices.

New didactics of reading and writing, as well as kinaesthetic forms of teaching, are – in themselves – already louder than teacher-centred instruction. A new challenge. Optimal room acoustics improve speech and reading comprehension as well as memory performance, lead to lower noise stress and reduce voice and hearing problems.

Activity-based acoustic design

Activities in a classroom differ from those in specialised rooms, in the canteen, in general shared spaces, or in a sports hall. Therefore, each room must be considered separately. The most important indicators are the current noise level, measured in decibels [dB], the reverberation time (seconds [s]) and the speech intelligibility – Speech Transmission Index (STI). When planning classrooms, the three influencing factors of activity, people, and space must be considered. How many people is the room intended for? Which teaching or learning methods are used? Are machines or other equipment used? How is the room structured? All these factors have a significant influence on the interior design and thus on human well-being and health.

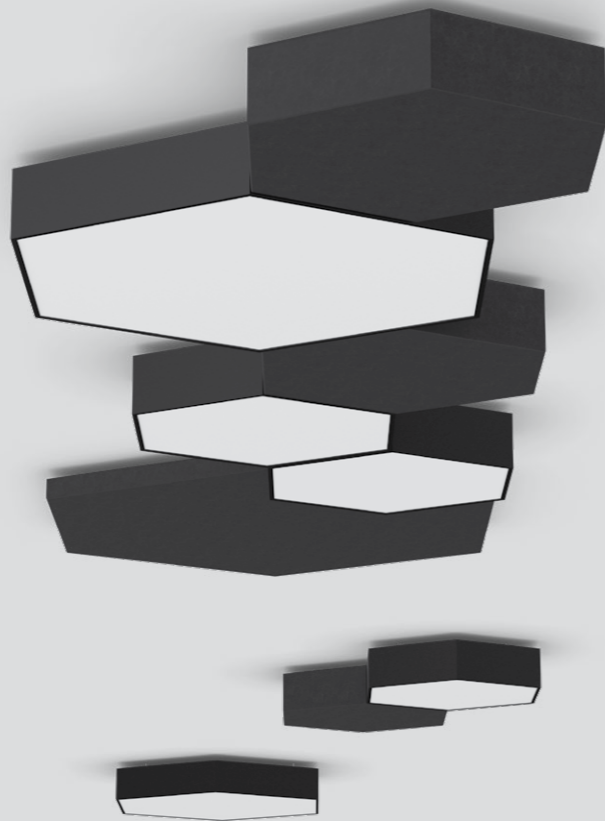

Limitless acoustics

Acoustics are complex and affects well-being, the daily work routine, and human health. The requirements often cannot be covered by the product portfolio of a single company. Therefore, we work with a network of different partners to perfectly coordinate light and acoustics. We offer acoustic planning in three service packages, which include different services depending on room size and specific project requirements. We design different variants for each project, including an acoustically optimised best-case scenario. If you have any questions or would like personalised advice on your project, please contact us at acoustics.planning@xal.com.



MUSE acoustic
suspended

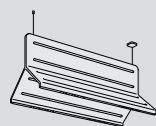

HEX-O acoustic
surface/suspended

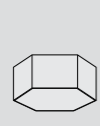

MINO CIRCLE
surface/suspended

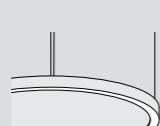

TASK acoustic
suspended

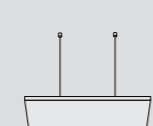

MOVE IT acoustic
system inlay



SONIC acoustic
suspended

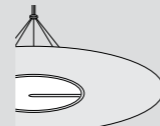

Classrooms

A classroom must allow for mutual intelligibility of students and teachers. The Speech Intelligibility Index (STI) indicates the percentage of spoken information reaching the listener. It lies in the range between 0 (incomprehensible) and 1 (excellent) and should be adapted to the different groups in the room. It is important to reduce the reverberation time, especially in larger classrooms, and to direct the sound to achieve good speech intelligibility throughout the room. The STI nominal value in teaching classes is regulated by the DIN 60286-16 standard and is at least 0.62. In the equipped simulation, the STI is 0.71 – even complex messages and unknown vocabulary can thus be very well captured.

Cafeteria and canteen

Eat, drink, and relax. Many people meet in the cafeteria. High sound levels are created by conversations or the clinking of crockery and the constant coming and going of people. The reverberation time must be reduced to enable conversations and to minimise the propagation of sound into adjacent areas. The reverberation time is regulated by the standards DIN 18041 and ÖNORM B 8115-3. Depending on the dimensions, there is a specified maximum reverberation time of about 0.5 seconds. The reverberation time of the empty canteen is 2.58 s in our simulation, which we dropped to 0.55 s in the equipped room.

Specialised classrooms

Music lessons, laboratories, workshops, computer classes: Specialised classrooms of all kinds are rooms with the most diverse requirements in terms of acoustics, hygiene, and light. People are lecturing, requiring good speech intelligibility, and loud equipment is being used. The reduced reverberation time also lowers the sound pressure level. This happens both through the reduction of reverberation and calmer behaviour of those in the room. We achieved a 10dB reduction in the sound pressure level (SPL) in our example, thanks to acoustic measures. This corresponds to a halving of the perceived volume.

Corridors and shared spaces

These spaces often represent a building's heart and are often used as communication hubs. They often set the atmosphere of the entire building. A corridor often serves as a hangout space and is used as a learning area and group workspace during lessons. A high noise level in the corridor disturbs those who are in the corridor and anyone in adjacent rooms. The measures taken in this simulation result in a 10dB SPL reduction. People in this area can study in peace and quiet without disturbing adjacent classes.

Sports halls

Sports, especially competitions and ball sports, are often associated with high sound levels. There is a tendency to also slightly underestimate how important it is to be able to give clear and prompt instructions without having to shout. This applies to teachers and trainers who spend extended periods in the sports hall, and it also helps to prevent accidents. A very good reverberation time and speech intelligibility is delivered by a well-thought-out acoustic concept. In this simulation, the reverberation time of over 4 seconds in an empty room is reduced to 1.1 seconds. This also has a very positive effect on speech intelligibility. The STI increases from 0.48 to over 0.7.

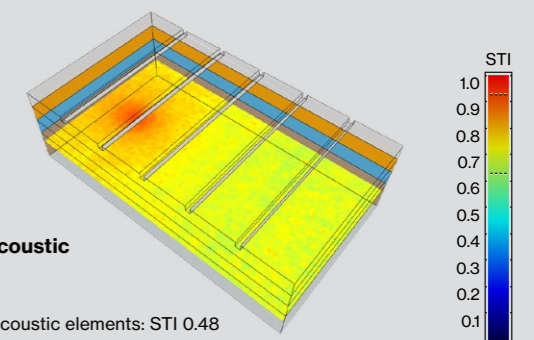
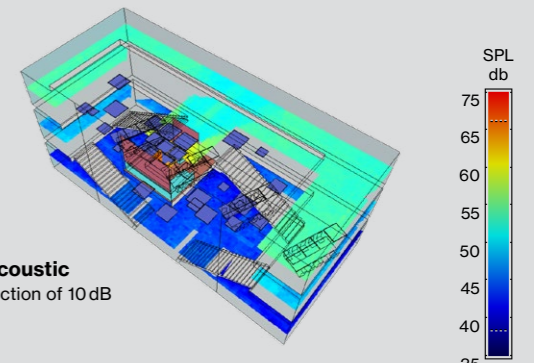
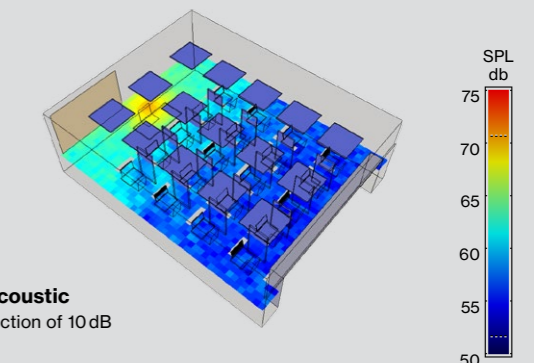
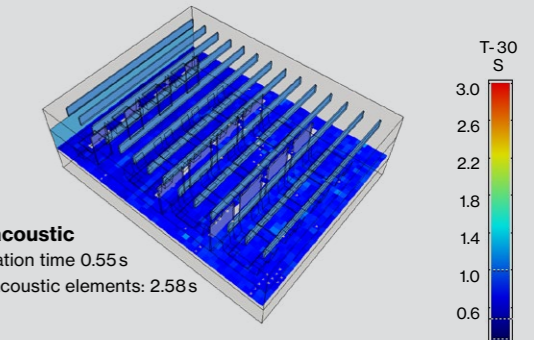
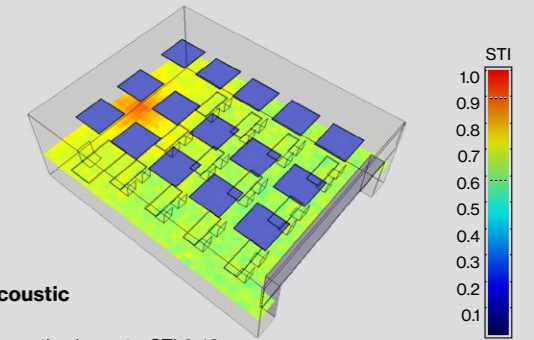

Classroom planning examples

We are on-site for you – simulated in this case. You will find a selection of different simulations of a classroom with common structural conditions on the following pages. They are based on a 72m² lecture hall for 24 learners, with a blackboard, and a table for the lecturer(s).

Concrete and plasterboard ceilings or grid ceilings are simulated in combination with various mounting variants from several luminaire series: recessed, surface-mounted, and suspended.

Lighting requirements

- equal visual conditions in every seat
- variable light intensity (500–1000 lx)
- board lighting with high uniformity
- good facial recognition
- raised cylindrical illuminance levels and good modelling
- good glare control (UGR ≤ 16/19)
- optional: dynamic light (TW D/I for HCL planning concepts) and pre-programmed lighting scenes
- optional: highly efficient luminaires with daylight/presence sensor technology for low energy consumption

Specifications

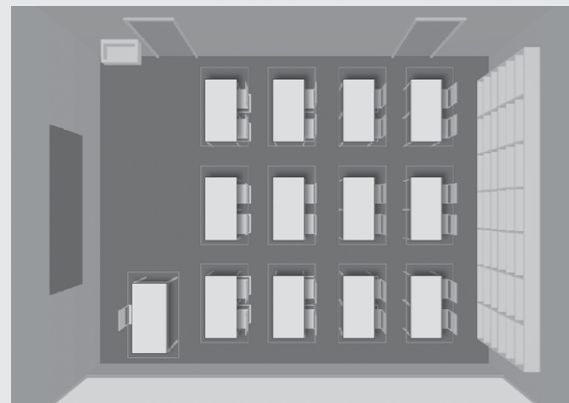

Standard classroom

Room dimensions
9.5 × 7.5 m (72 m²)
Room height: 3 m

Equipment
Board W/H: 3.3 × 1.2 m teaching aid cabinet
24 pupils (double tables or single tables)

Measured surface

Visual task horizontal (height of measuring plane 0.75 m)

Vertical board

Vertical walls and teaching aid cabinet (height of measuring plane 0.5–2 m)

Ceiling

Cylindrical light intensity

• Modelling factor*
• UGR observer

Light intensity

E_m 300 – 500 lx / U_0 0.6

E_m 500–750 lx / U_0 0.7

E_m 150 lx / U_0 0.1

E_m 100 lx / U_0 0.1

E_z 150 lx / U_0 0.1

0.3 – 0.6
≤ 19

* Modelling factor: The modelling describes the relationship between cylindrical and horizontal illuminance E_h at one point and should be in an interval between 0.30 and 0.60.

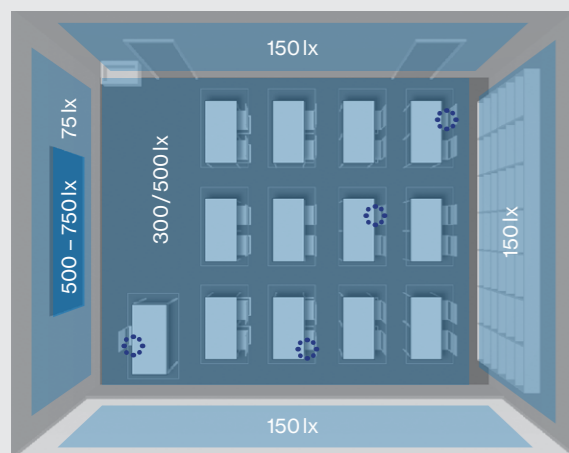

UNICO

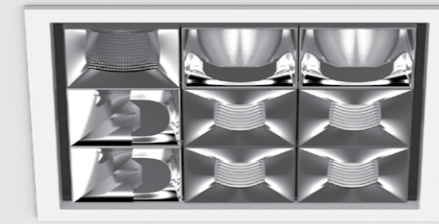

UNICO Q9 basic
recessed



UNICO L6 basic
wallwasher floor
recessed

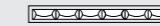

Ceiling
Plasterboard ceiling / Concrete ceiling

Visual comfort
3000 K, 4000 K
CRI ≥ 90 / UGR ≤ 19 / 65° ≤ 3000 cd/m²

Optional
Motion and daylight sensor

USPs
High quality of stay,
best lighting quality

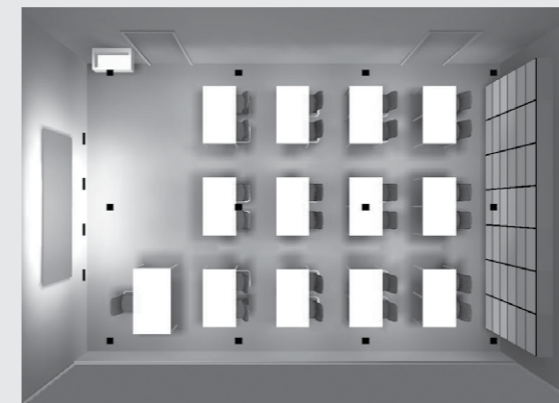
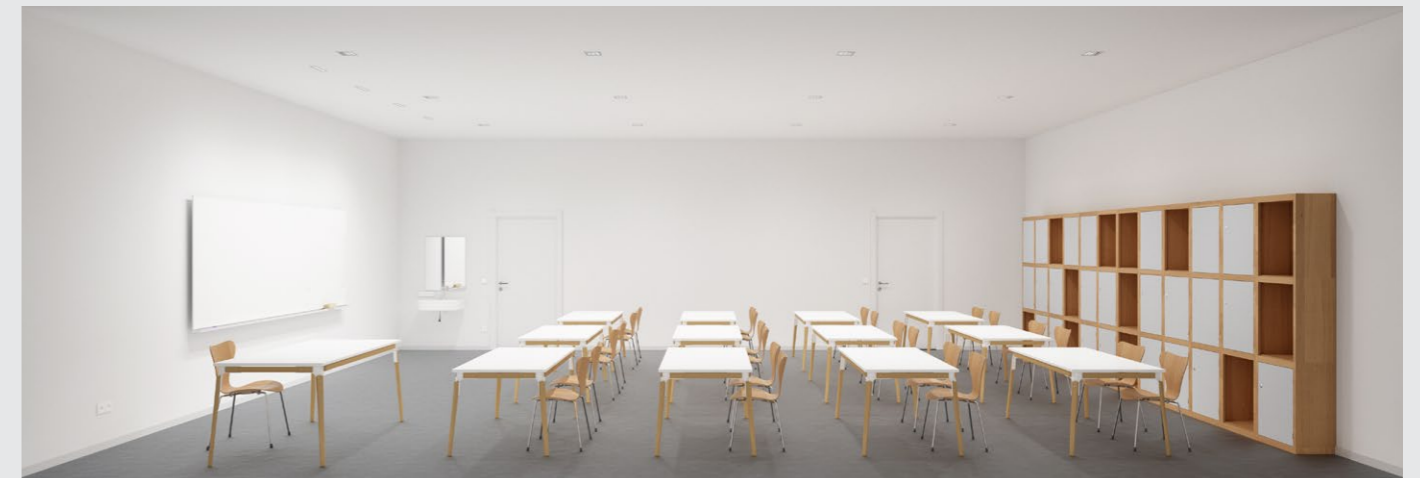

Quantity	Luminaire	Dimming level
12	UNICO Q9 basic trim, flood square (UGR ≤ 19) 4000 K, 36 W	75%
4	UNICO L6 (WFW) 4000 K, 22.9 W	100%

System performance power consumption	526 W 5.9 W/m ²	System dimmed
Modelling factor UGR (Viewer)	0.40 ≤ 10	

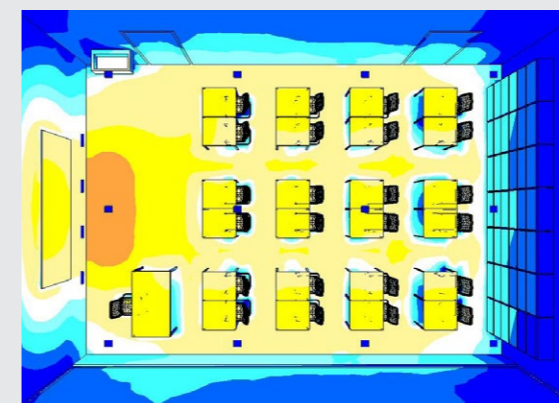

Measured surface	Light intensity	Uniformity
Visual task Room horizontal	E_m 520 lx	U_0 0.70
Board vertical	E_m 515 lx	U_0 0.71
Ceiling	E_m 110 lx	U_0 0.60
Walls vertical	E_m ≥ 150 lx	U_0 ≥ 0.50
Teaching aid cabinet	E_m ≥ 150 lx	U_0 0.57
Cylindrical light intensity	E_m ≥ 250 lx	U_0 ≥ 0.90

BETO



BETO system ceiling

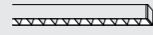

BETO blackboard system ceiling

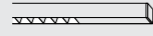

Ceiling
Plasterboard ceiling / Concrete ceiling

Visual comfort
3000 K, 4000 K
CRI ≥ 80 / UGR ≤ 19 / 65° ≤ 3000 cd/m²

Optional
Motion and daylight sensor

USPs
Pleasant feeling of space
Highest visual comfort

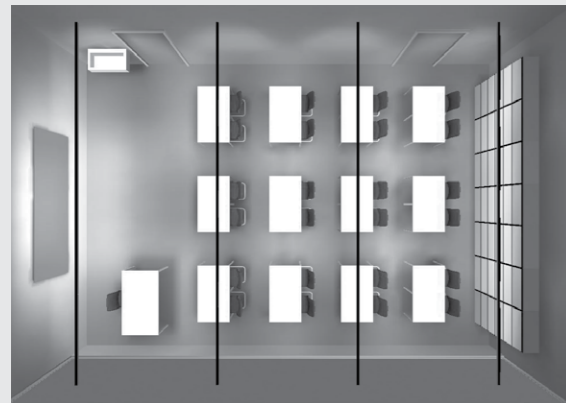

Quantity	Luminaire	Dimming level
3	BETO system, 6800 mm 4000 K, 104 W	75 %
1	BETO blackboard system, 6800 mm 4000 K, 148 W	75 %

System performance power consumption	468 W 5.3 W/m²	System dimmed
Modelling factor UGR (Viewer)	0.43 ≤ 16.6	

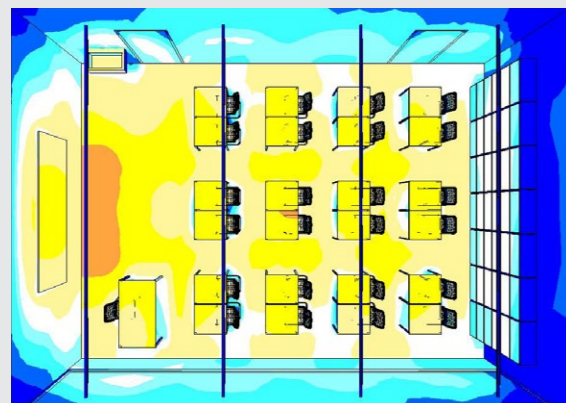

Measured surface	Light intensity	Uniformity
Visual task Room horizontal	E_m 540 lx	U_0 0.68
Board vertical	E_m 520 lx	U_0 0.77
Ceiling	E_m 115 lx	U_0 0.55
Walls vertical	E_m ≥ 150 lx	U_0 ≥ 0.45
Teaching aid cabinet	E_m 275 lx	U_0 0.60
Cylindrical light intensity	E_m ≥ 240 lx	U_0 ≥ 0.82

75 100 150 200 300 500 750 1000 [lx]

TASK round



TASK 600 round ceiling



UNICO L6 basic wallwasher floor recessed



Ceiling
Plasterboard ceiling / Concrete ceiling

Visual comfort
3000 K, 4000 K
CRI ≥ 80 / UGR ≤ 19 / 65° ≤ 3000 cd/m²

Optional
Motion and daylight sensor

USPs
Pleasant feeling of space
Design variety (types & sizes)

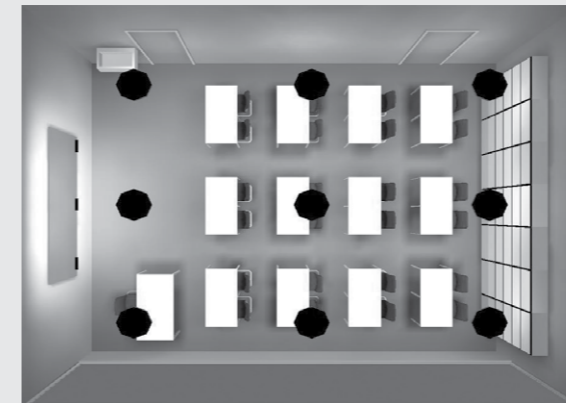

Quantity	Luminaire	Dimming level
9	TASK 600 round ceiling 4000 K, 40.7 W	90 %
3	UNICO L6 basic (WWF) 4000 K, 22.9 W	100 %

System performance power consumption	438 W 5.6 W/m²	System dimmed
Modelling factor UGR (Viewer)	0.43 ≤ 16.2	

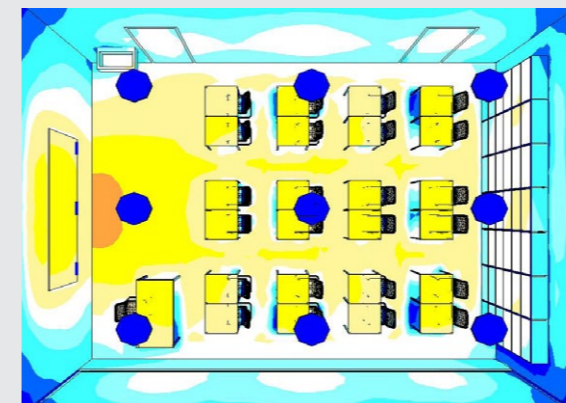

Measured surface	Light intensity	Uniformity
Visual task Room horizontal	E_m 560 lx	U_0 0.69
Board vertical	E_m 575 lx	U_0 0.72
Ceiling	E_m 120 lx	U_0 0.15
Walls vertical	E_m ≥ 185 lx	U_0 ≥ 0.60
Teaching aid cabinet	E_m 280 lx	U_0 0.76
Cylindrical light intensity	E_m ≥ 200 lx	U_0 ≥ 0.90

75 100 150 200 300 500 750 1000 [lx]

TASK S

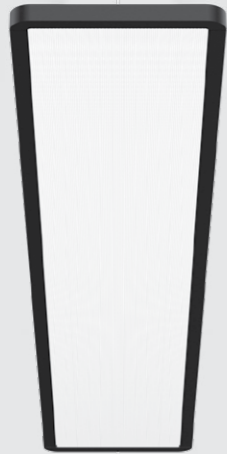

TASK S linear
suspended



UNICO L6 basic
wallwasher floor
recessed

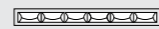

Ceiling
Plasterboard ceiling / Concrete ceiling

Visual comfort
3000 K, 4000 K
CRI ≥ 80 / UGR ≤ 19

Optional
Motion and daylight sensor

USPs
Pleasant feeling of space
Few connection points

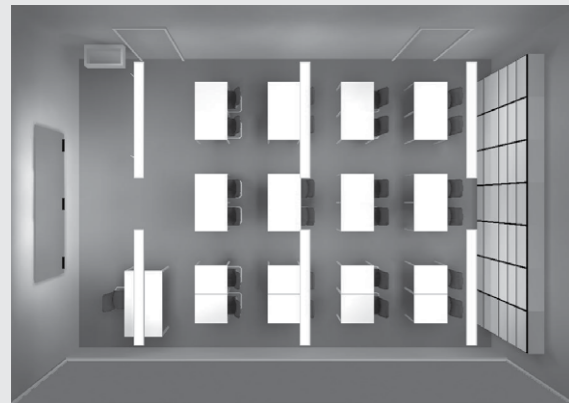
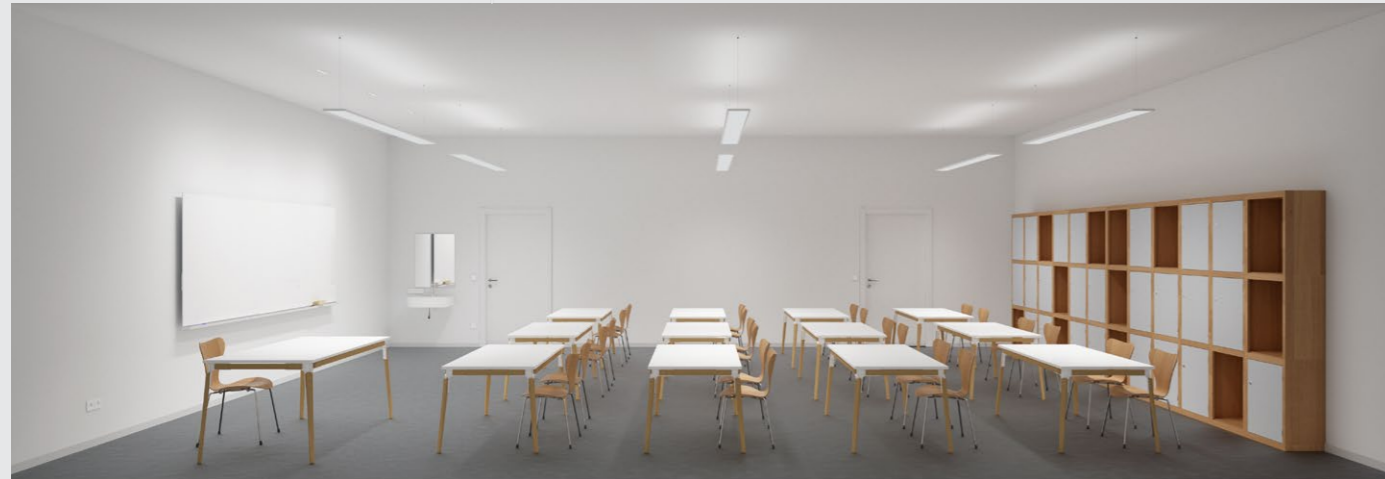

Quantity	Luminaire	Dimming level
12	TASK S suspended D/I soft 1748 mm, 4000 K, 87,5 W	65 %
3	UNICO L6 basic (WWF) 4000 K, 22.9 W	85 %

System performance power consumption	596 W 5.7 W/m ²	System dimmed
Modelling factor UGR (Viewer)	0,46 ≤ 17.0	



Measured surface	Light intensity	Uniformity
Visual task Room horizontal	E _m 550 lx	U ₀ 0.67
Board vertical	E _m 535 lx	U ₀ 0.75
Ceiling	E _m 350 lx	U ₀ 0.30
Walls vertical	E _m ≥ 200 lx	U ₀ ≥ 0.50
Teaching aid cabinet	E _m 300 lx	U ₀ 0.65
Cylindrical light intensity	E _m ≥ 235 lx	U ₀ ≥ 0.72

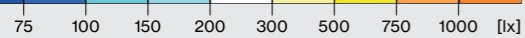

FRAME



FRAME 100 system
recessed



FRAME 100 system
wallwasher
recessed



Ceiling
Plasterboard ceiling / Concrete ceiling

Visual comfort
3000 K, 4000 K
CRI ≥ 80 / UGR ≤ 19

Optional
Motion and daylight sensor

USPs
Pleasant feeling of space
Few connection points

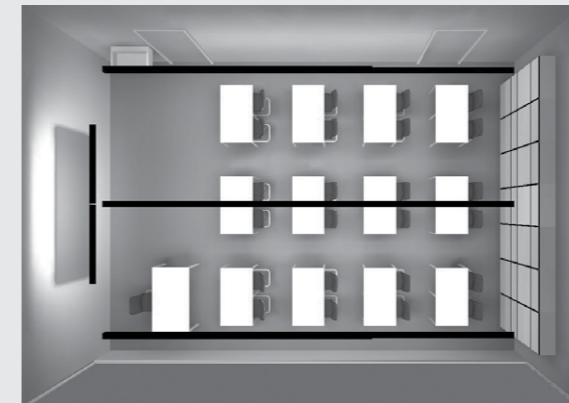

Quantity	Luminaire	Dimming level
3	FRAME 100 system 6000 mm (UGR ≤ 19), 4000 K, 103.5 W	80 %
1	FRAME 100 wallwasher system 3000 mm, 4000 K, 100 W	100 %

System performance power consumption	512 W 6.1 W/m ²	System dimmed
Modelling factor UGR (Viewer)	0.45 ≤ 17.8	

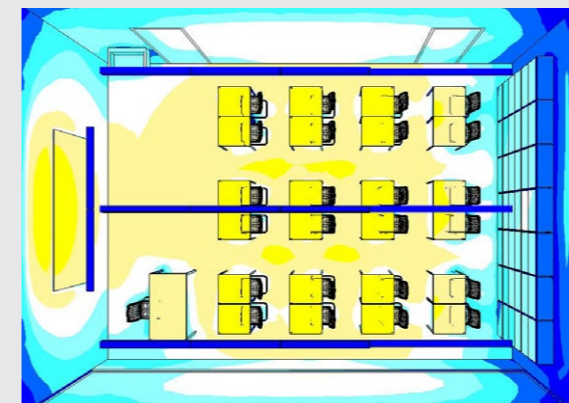

Measured surface	Light intensity	Uniformity
Visual task Room horizontal	E _m 550 lx	U ₀ 0.63
Board vertical	E _m 535 lx	U ₀ 0.70
Ceiling	E _m 115 lx	U ₀ 0.65
Walls vertical	E _m ≥ 160 lx	U ₀ ≥ 0.40
Teaching aid cabinet	E _m 220 lx	U ₀ 0.60
Cylindrical light intensity	E _m ≥ 215 lx	U ₀ ≥ 0.80

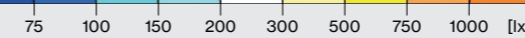

MITA square



MITA square
recessed



SQUADRO 1x2
wallwasher floor
recessed



Ceiling
Plasterboard ceiling / Grid ceiling

Visual comfort
3000 K, 4000 K
CRI ≥ 80 / UGR ≤ 19 / 65° ≤ 1500 cd/m²

Optional
Motion and daylight sensor

USPs
Highest visual comfort
Few connection points

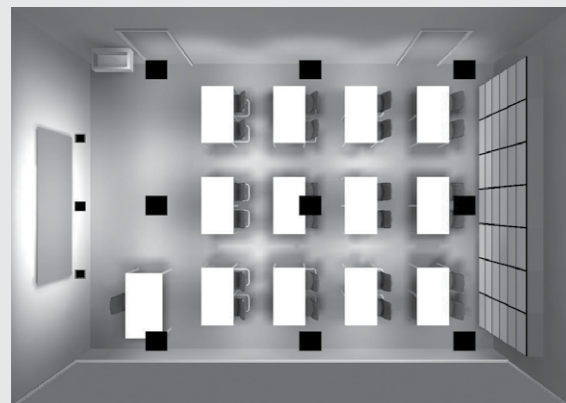
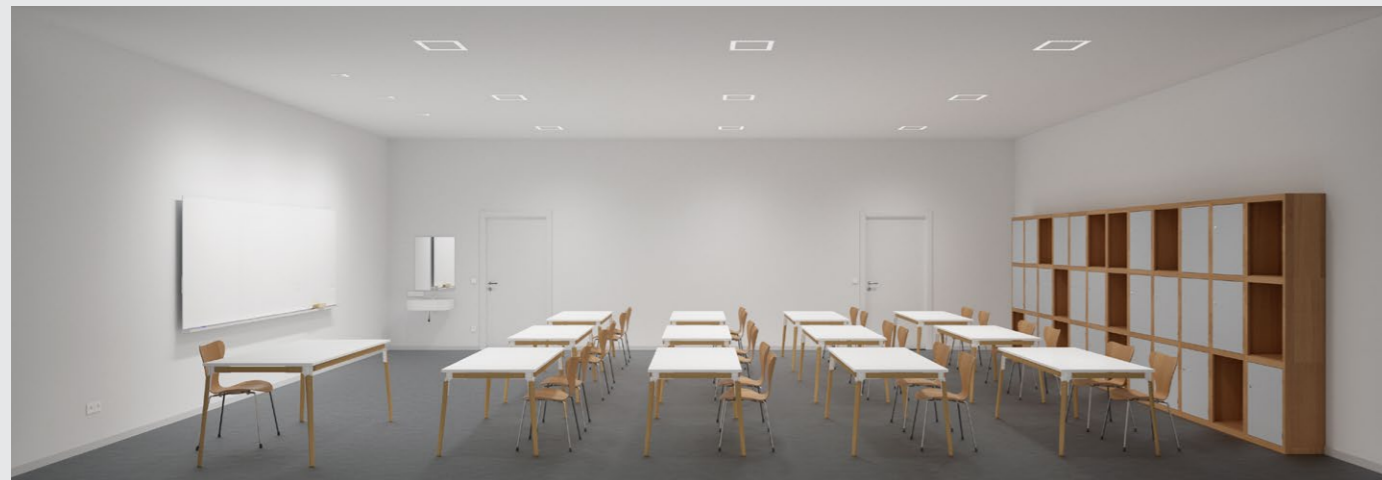

Quantity	Luminaire	Dimming level
9	BETO 450 square 4000 K, 28 W	100 %
3	SQUADRO 1x2 WWF 4000 K, 25.3 W	85 %

System performance power consumption	328 W 4.5 W/m²	System dimmed
Modelling factor UGR (Viewer)	0.43 ≤ 19	

Measured surface	Light intensity	Uniformity
Visual task Room horizontal	E_m 540 lx	U_0 0.78
Board vertical	E_m 515 lx	U_0 0.74
Ceiling	E_m 110 lx	U_0 0.57
Walls vertical	E_m ≥ 100 lx	U_0 ≥ 0.37
Teaching aid cabinet	E_m 150 lx	U_0 0.56
Cylindrical light intensity	E_m ≥ 200 lx	U_0 ≥ 0.62

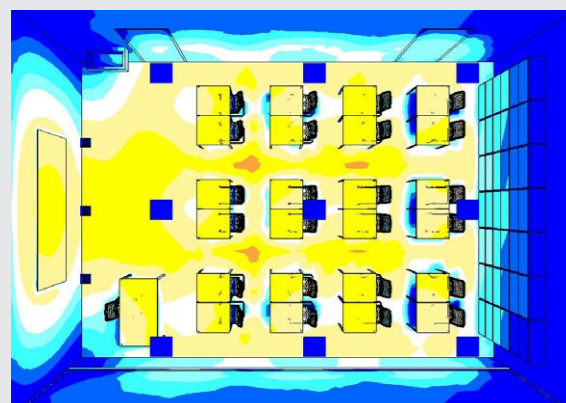

75 100 150 200 300 500 750 1000 [lx]

SONO



SONO
260 / 450 / 600
surface



Ceiling
Plasterboard ceiling / Concrete ceiling

Visual comfort
3000 K / CRI ≥ 80 / UGR ≤ 22
photobio. safety RG 0 - no Risk

Optional
SONO surface direct/indirect

USPs
High protection (IP 54 & IK 07)
Design freedom (sizes & mounting)

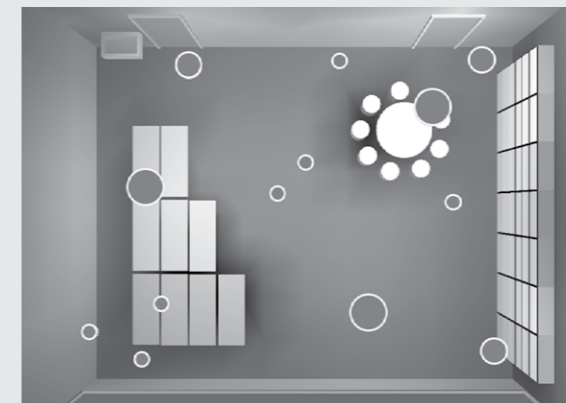

Quantity	Luminaire	Dimming level
7	SONO 255 direct	100 %
3	SONO 445 direct	100 %
3	SONO 595 direct	100 %

System performance power consumption	253 W 3.6 W/m²	
Modelling factor UGR (Viewer)	0.46 ≤ 22	

Measured surface	Light intensity	Uniformity
Room horizontal	E_m 340 lx	U_0 0.50
Ceiling	E_m 80 lx	U_0 0.57
Walls vertical	E_m ≥ 160 lx	U_0 ≥ 0.40
Teaching aid cabinet	E_m 210 lx	U_0 0.65
Cylindrical light intensity	E_m ≥ 200 lx	U_0 ≥ 0.98

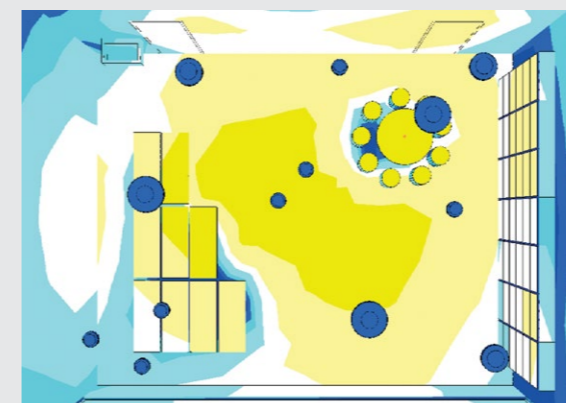

75 100 150 200 300 500 750 1000 [lx]

On a personal note

We develop and perfect projects in dialogue with the architects and planners to make them unique.

We see ourselves as your partner. From lighting design, the right product selection and control system to commissioning and maintenance, we are at your side throughout your project. Let's talk about your project: office@xal.com



XAL Headquarters

XAL GmbH
Auer-Welsbach-Gasse 36
8055 Graz

AUSTRIA
T +43.316.3170
office@xal.com

All locations:
xal.com/contacts

Legend

ball-impact resistant



shock resistance IK07

List of photographers

Jeffery Edwards (p. 2), Marcel Kohnen (p. 6), Roman Weyeneth (p. 14), Linus Lintner (p. 14 | 27 | 39 | 42-43), David Schreyer (p. 15), Kris Dekeijser (p. 16 | 18-19 | 24), hertha hurnaus (p. 12 | 20-23 | 46 | 51 | 56 | 60), David Barbour (p. 26 | 28 | 36), Markus Käch (p. 28), Sabrina Scheja (p. 30), Kurt Kuball (p. 30), Markus Fattinger (p. 31), Oskar Da Riz (p. 32-33 | 35), Zooey Braun (p.38), Z. Gataric Fotografie (p. 40), Nick Caville (p. 42 | 50), Markus Kaiser (p. 44), Marc Manso (p. 50), Paul Ott (p. 54-55), Archipicture (p. 54 | 58), Tina Barth (p. 58), Tõnu Tunnel (p. 64), Kurt Kuball (p. 75)

Legal notices

The information in this catalogue corresponds to the status at the time of printing, is non-binding and is intended for information purposes only. No liability is assumed for deviations of a product from illustrations or specifications. We reserve the right to make changes to our products at any time. All orders are accepted exclusively based on our General Terms and Conditions of Business and Delivery, which can be viewed at www.xal.com, in the current version.

